

COMPONENTS	IMPEDANCE
3.5mm MALE	50 OHM
3.5mm FEMALE BULKHEAD	50 OHM

Standard Lengths	
-12	12"
-24	24"
-36	36"
-48	48"
-60	60"
-XXX	Custom Length in inches

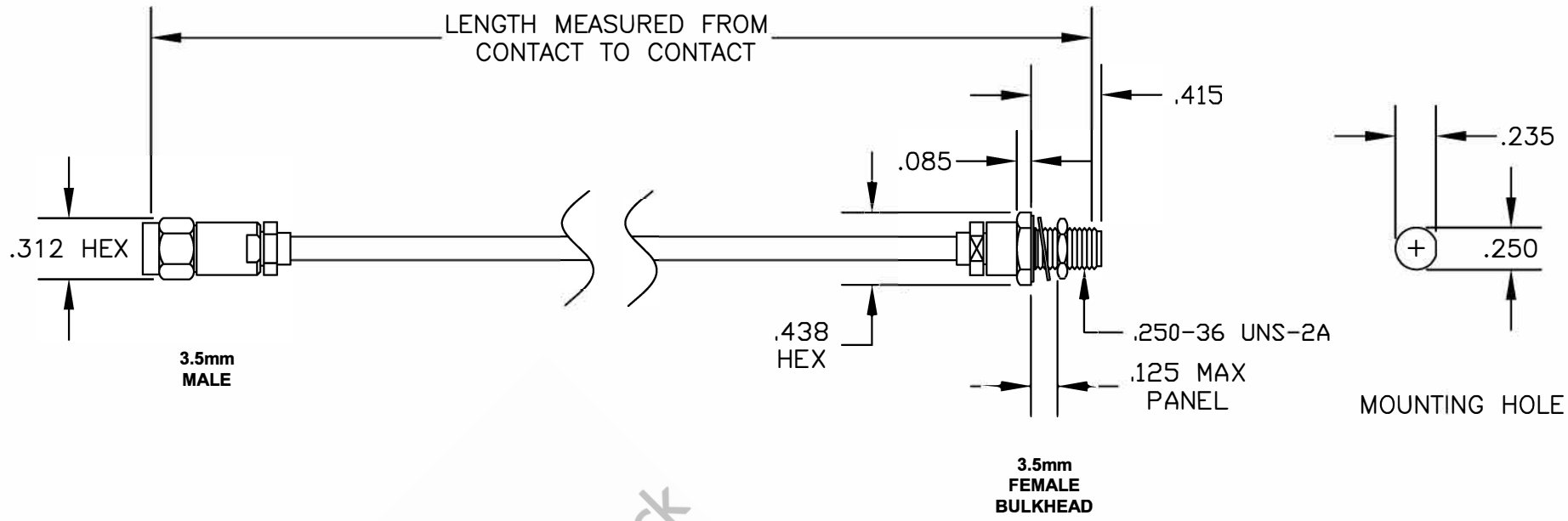

8TH FLOOR, BUILDING 1, YONGFU SCIENCE AND TECHNOLOGY CENTER INDUSTRIAL PARK, NANZHA DISTRICT 5, HUMEN, 523900, DONGGUAN, GUANGDONG, CHINA

ebeestock WEBSITE: www.ebeestock.com EMAIL: sales@ebeestock.com

DWG TITLE	DES.					
ET13835	CABLE ASSEMBLY, 3.5mm MALE TO 3.5mm FEMALE BULKHEAD					
SIZE A	FSCM NO. 53919	CAD FILE	082007	SCALE	N/A	127

- NOTES:**
- UNLESS OTHERWISE SPECIFIED ALL DIMENSIONS ARE NOMINAL.
 - ALL SPECIFICATIONS ARE SUBJECT TO CHANGE WITHOUT NOTICE AT ANY TIME.
 - DIMENSIONS ARE IN INCHES.
 - LENGTH TOLERANCE IS $\pm 1.5\%$ OR $\pm 3/8"$, WHICHEVER IS GREATER.