

COMPONENTS	IMPEDANCE
7/16 MALE	50 OHM
7/16 MALE	50 OHM
RG218/U	50 OHM

Standard Lengths	
-12	12"
-24	24"
-36	36"
-48	48"
-60	60"
-XXX	Custom Length in inches

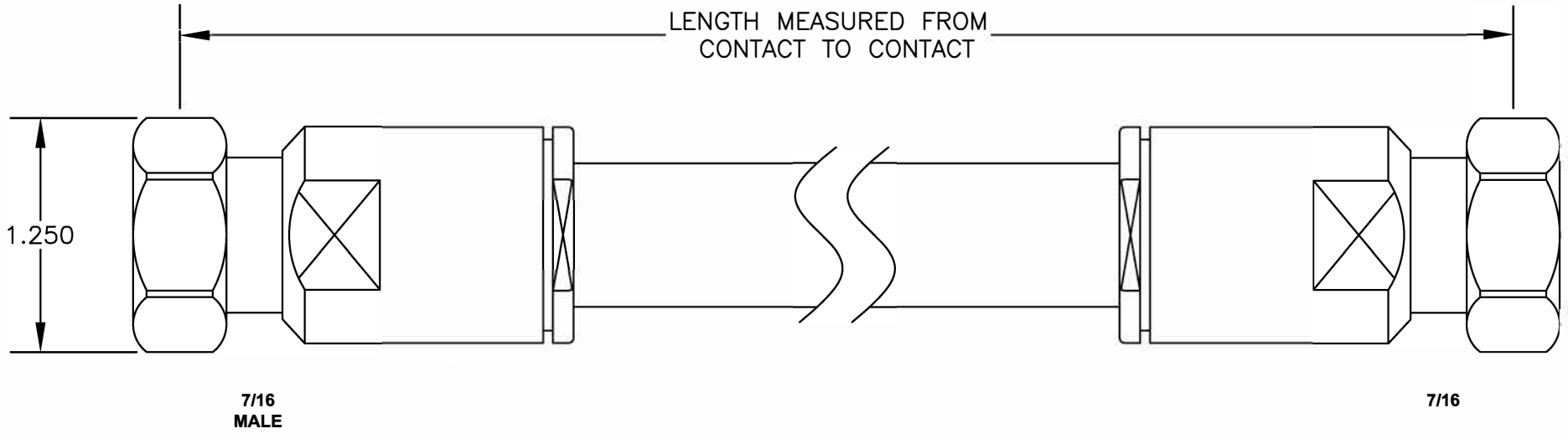

8TH FLOOR, BUILDING 1, YONGFU SCIENCE AND TECHNOLOGY
CENTER INDUSTRIAL PARK, NANZHA DISTRICT 5,
HUMEN, 523900, DONGGUAN, GUANGDONG, CHINA

WEBSITE: www.ebeestock.com
EMAIL: sales@ebeestock.com

ET15988

DES. CABLE ASSEMBLY, RG218/U, 7/16
MALE TO 7/16 MALE

REV. A	FSCM NO. 53919	CAD FILE 020608	SCALE N/A	SIZE A	147
--------	----------------	-----------------	-----------	--------	-----

NOTES:

1. UNLESS OTHERWISE SPECIFIED ALL DIMENSIONS ARE NOMINAL.
2. ALL SPECIFICATIONS ARE SUBJECT TO CHANGE WITHOUT NOTICE AT ANY TIME.
3. DIMENSIONS ARE IN INCHES.
4. LENGTH TOLERANCE IS ± 1.5% OR 10mm, WHICHEVER IS GREATER.