

COMPONENTS	IMPEDANCE
7/16 MALE	50 OHM
N MALE	50 OHM
RG218/U	50 OHM

Standard Lengths	
-12	12"
-24	24"
-36	36"
-48	48"
-60	60"
-XXX	Custom Length in inches

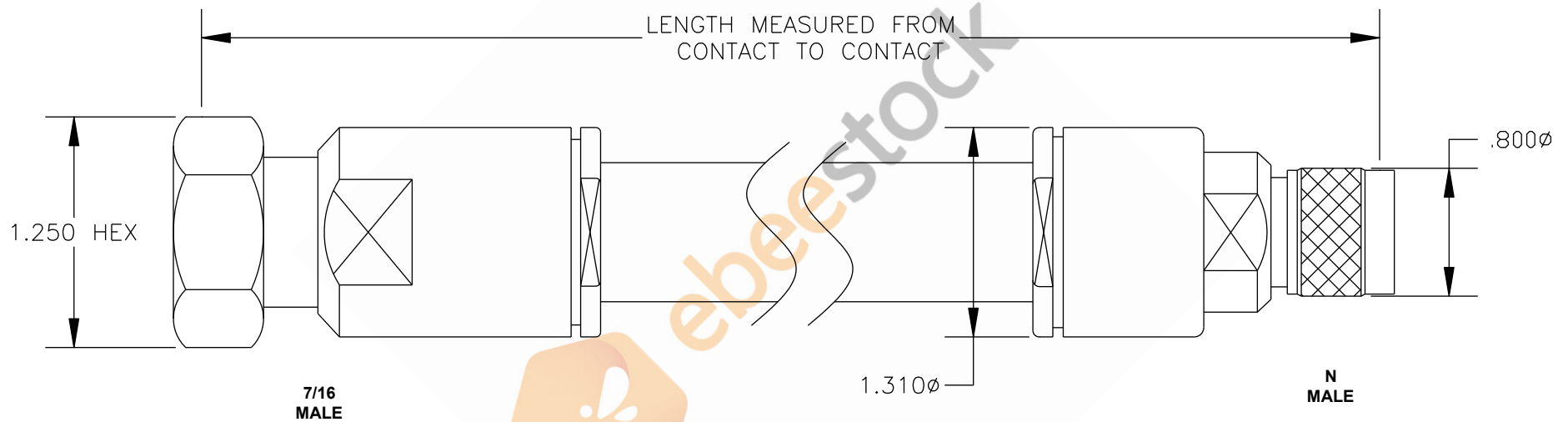

8TH FLOOR, BUILDING 1, YONGFU SCIENCE AND TECHNOLOGY CENTER INDUSTRIAL PARK, NANZHA DISTRICT 5, HUMEN, 523900, DONGGUAN, GUANGDONG, CHINA
 WEBSITE: www.ebeestock.com
 EMAIL: sales@ebeestock.com



RoHS
Compliance
Certified

DWG TITLE	DES.
ET17352	CABLE ASSEMBLY, RG218/U, 7/16 MALE TO N MALE (LEAD FREE)

REV. A	FSCM NO. 53919	CAD FILE 021208	SCALE N/A	SIZE A	147
--------	----------------	-----------------	-----------	--------	-----

- NOTES:
- UNLESS OTHERWISE SPECIFIED ALL DIMENSIONS ARE NOMINAL.
 - ALL SPECIFICATIONS ARE SUBJECT TO CHANGE WITHOUT NOTICE AT ANY TIME.
 - DIMENSIONS ARE IN INCHES.
 - LENGTH TOLERANCE IS $\pm 1.5\%$ OR $\pm 3/8"$, WHICHEVER IS GREATER.