

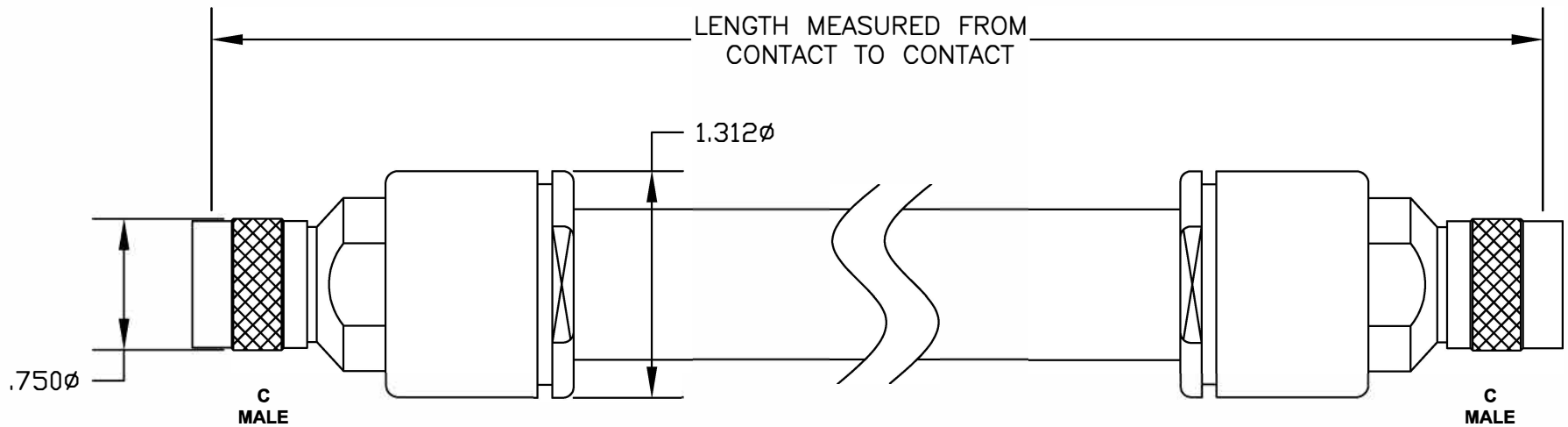

COMPONENTS	IMPEDANCE
C MALE	50 OHM
C MALE	50 OHM
RG218/U	50 OHM

Standard Lengths	
-12	12"
-24	24"
-36	36"
-48	48"
-60	60"
-XXX	Custom Length in inches



 8TH FLOOR, BUILDING 1, YONGFU SCIENCE AND TECHNOLOGY CENTER INDUSTRIAL PARK, MANZHA DISTRICT 5, HUMEN, 523900, DONGGUAN, GUANGDONG, CHINA	
ebeestock	
WEBSITE: www.ebeestock.com EMAIL: sales@ebeestock.com	
TITLE ET21558	
DES. CABLE ASSEMBLY, RG218/U, C MALE TO C MALE	
SIZE A FSCM NO.53919	CAD FILE 030807
SCALE N/A	127
NOTES: 1. UNLESS OTHERWISE SPECIFIED ALL DIMENSIONS ARE NOMINAL. 2. ALL SPECIFICATIONS ARE SUBJECT TO CHANGE WITHOUT NOTICE AT ANY TIME. 3. DIMENSIONS ARE IN INCHES. 4. LENGTH TOLERANCE IS $\pm 1.5\%$ OR $\pm 3/8"$, WHICHEVER IS GREATER.	