

COMPONENTS	IMPEDANCE
FAKRA PLUG	50 OHM
FAKRA PLUG	50 OHM
RG174A/U	50 OHM

Standard Lengths	
-12	12"
-24	24"
-36	36"
-48	48"
-60	60"
-XXX	Custom Length in Inches





Part Configurator

1. Replace Y with code.
2. Replace XX with length in inches.

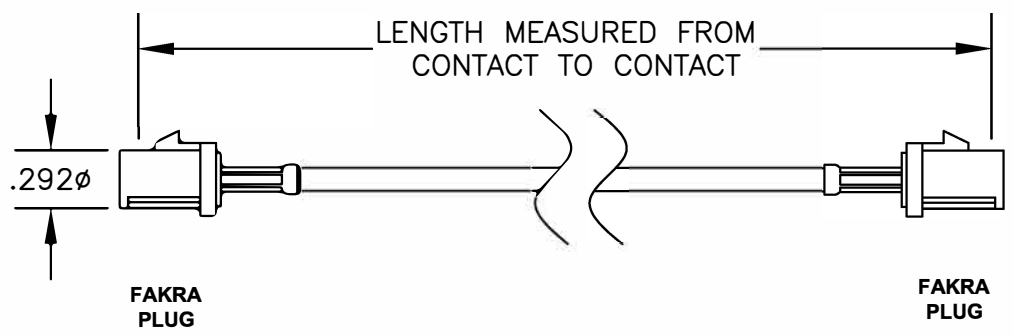
CODING	PLUG	PLUG	COLOR	APPLICATION
A			BLACK	RADIO WITH PHANTOM SUPPLY
B			WHITE	RADIO WITHOUT PHANTOM SUPPLY
C			BLUE	GPS: TELEMATICS OR NAVIGATION
D			BORDEAUX	GSM: CELLULAR PHONE
H			VIOLET	GPS: TELEMATICS AND NAVIGATION
I			BEIGE	BLUETOOTH
K			CURRY	RADIO WITH IF OUTPUT (ANTENNA DIVERSITY)
Z			WATER BLUE	NEUTRAL CODING



		8TH FLOOR, BUILDING 1, YONGFU SCIENCE AND TECHNOLOGY CENTER INDUSTRIAL PARK, NANZHA DISTRICT 5, HUMEN, 523900, DONGGUAN, GUANGDONG, CHINA			
		WEBSITE: www.ebeestock.com EMAIL: sales@ebeestock.com			
TITLE ET21987		DES. FAKRA PLUG TO FAKRA PLUG, RG174A/U COAX			
REV.	FSCMNO. 53919	CAD FILE	052009	SCALE	N/A
		SIZE	A	127	
NOTES: 1. UNLESS OTHERWISE SPECIFIED ALL DIMENSIONS ARE NOMINAL. 2. ALL SPECIFICATIONS ARE SUBJECT TO CHANGE WITHOUT NOTICE AT ANY TIME. 3. DIMENSIONS ARE IN INCHES. 4. LENGTH TOLERANCE IS $\pm 1.5\%$ OR $3/8"$, WHICHEVER IS GREATER.					