

COMPONENTS	IMPEDANCE
N MALE RIGHT ANGLE	50 OHM
N FEMALE BULKHEAD	50 OHM
RG393/U	50 OHM

Standard Lengths	
-12	12"
-24	24"
-36	36"
-48	48"
-60	60"
-XXX	Custom Length in inches

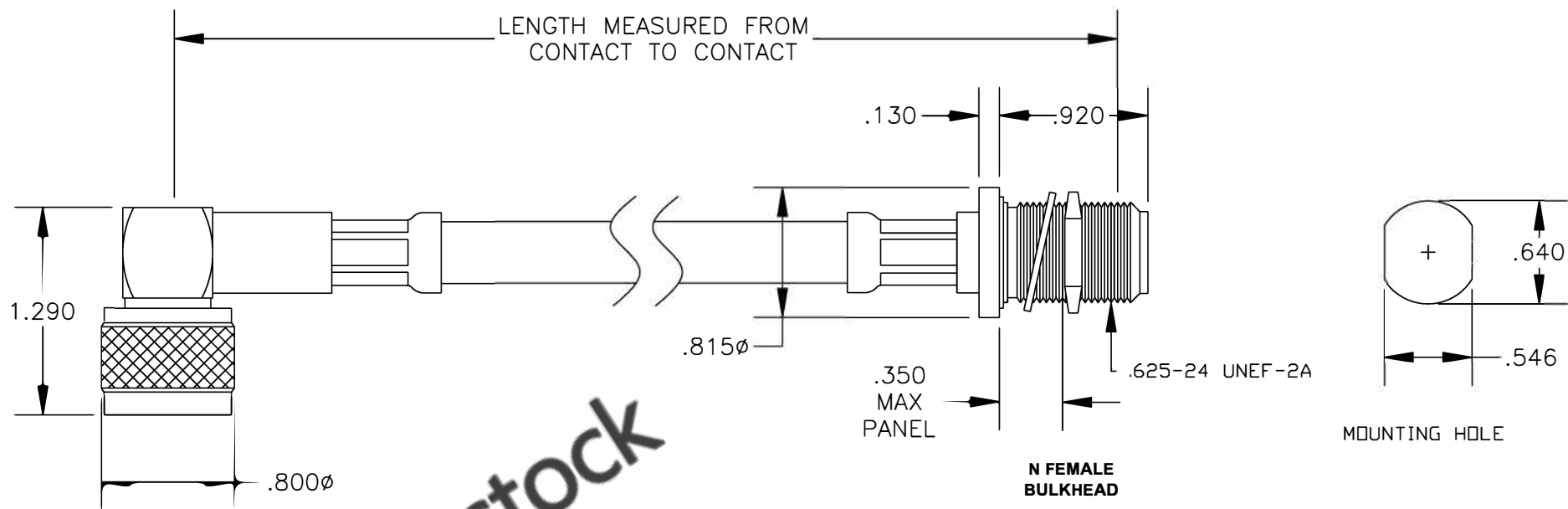

8TH FLOOR, BUILDING 1, YONGFU SCIENCE AND TECHNOLOGY CENTER INDUSTRIAL PARK, NANZHA DISTRICT 5, HUMEN, 523900, DONGGUAN, GUANGDONG, CHINA
 WEBSITE: www.ebeestock.com
 EMAIL: sales@ebeestock.com
COAXIAL & FIBER OPTICS

ET26745		DES. CABLE ASSEMBLY, RG393/U, N MALE RIGHT ANGLE TO N FEMALE BULKHEAD	
----------------	--	---	--

REV. A	FSCM NO. 53919	CAD FILE 012408	SCALE N/A	SIZE A	147
--------	-----------------------	-----------------	-----------	--------	-----

- NOTES:**
1. UNLESS OTHERWISE SPECIFIED ALL DIMENSIONS ARE NOMINAL.
 2. ALL SPECIFICATIONS ARE SUBJECT TO CHANGE WITHOUT NOTICE AT ANY TIME.
 3. DIMENSIONS ARE IN INCHES.
 4. LENGTH TOLERANCE IS $\pm 1.5\%$ OR $\pm 3/8"$, WHICHEVER IS GREATER.