

COMPONENTS	IMPEDANCE
N MALE	50 OHM
N FEMALE BULKHEAD	50 OHM
PE-047SR	50 OHM

Standard Lengths	
-12	12"
-24	24"
-36	36"
-48	48"
-60	60"
-XXX	Custom Length in inches

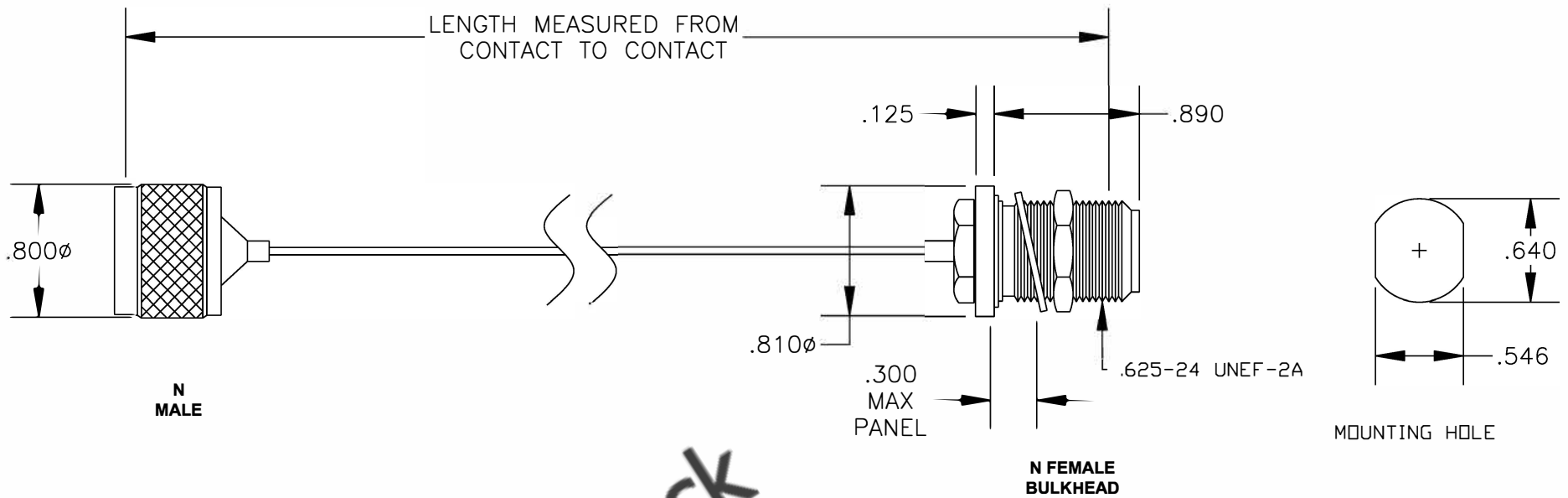

**8TH FLOOR, BUILDING 1, YONGFU SCIENCE AND TECHNOLOGY CENTER INDUSTRIAL PARK, NANZHA DISTRICT 5, HUMEN, 523900, DONGGUAN, GUANGDONG, CHINA**  
 WEBSITE: [www.ebeeStock.com](http://www.ebeeStock.com)  
 EMAIL: [sales@ebeeStock.com](mailto:sales@ebeeStock.com)  
**COAXIAL & FIBER OPTICS**

<b>ET26969</b>		DES. CABLE ASSEMBLY, PE-047SR, N MALE TO N FEMALE BULKHEAD	
----------------	--	--	--

REV. A	<b>FSCM NO. 53919</b>	CAD FILE 012508	SCALE N/A	SIZE A 147
--------	-----------------------	-----------------	-----------	------------

- NOTES:**
1. UNLESS OTHERWISE SPECIFIED ALL DIMENSIONS ARE NOMINAL.
  2. ALL SPECIFICATIONS ARE SUBJECT TO CHANGE WITHOUT NOTICE AT ANY TIME.
  3. DIMENSIONS ARE IN INCHES.
  4. LENGTH TOLERANCE IS  $\pm 1.5\%$  OR  $\pm 3/8"$ , WHICHEVER IS GREATER.