

COMPONENTS	IMPEDANCE
N MALE	50 OHM
N FEMALE BULKHEAD	50 OHM
PE-SR402AL	50 OHM

Standard Lengths	
-12	12"
-24	24"
-36	36"
-48	48"
-60	60"
-XXX	Custom Length in inches

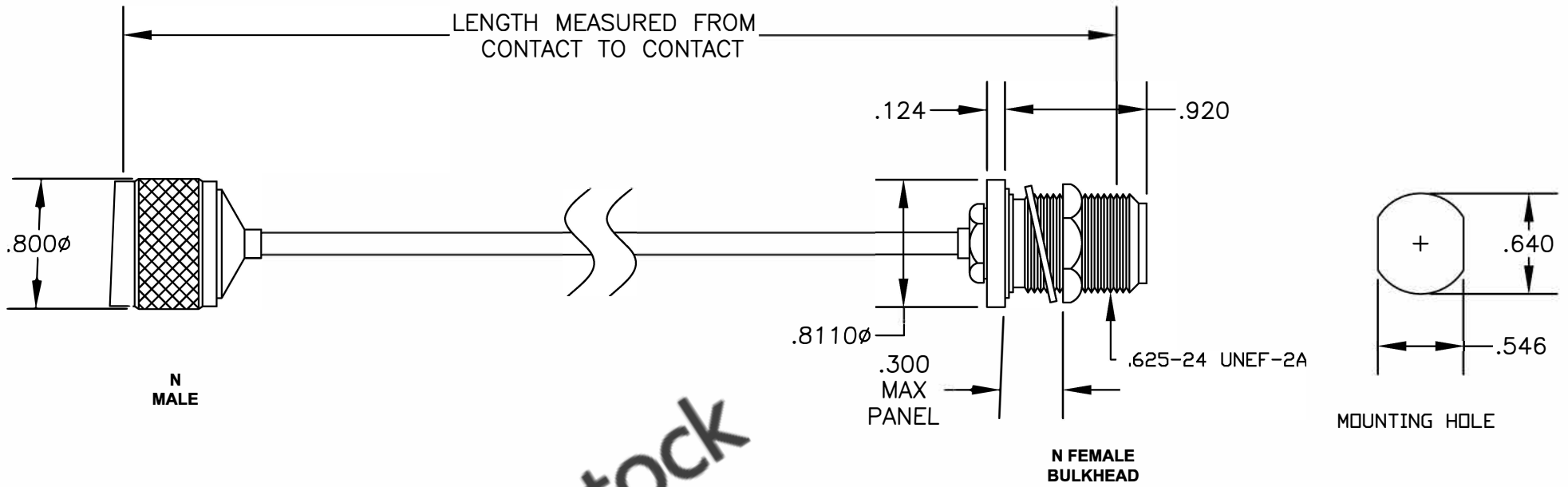

8TH FLOOR, BUILDING 1, YONGFU SCIENCE AND TECHNOLOGY CENTER INDUSTRIAL PARK, NANZHA DISTRICT 5, HUMEN, 523900, DONGGUAN, GUANGDONG, CHINA
 WEBSITE: www.ebeestock.com
 EMAIL: sales@ebeestock.com
COAXIAL & FIBER OPTICS

ET27016

DES. CABLE ASSEMBLY, PE-SR402AL, N MALE TO N FEMALE BULKHEAD

SIZE A	FSCMNO.53919	CAD FILE	060407	SCALE	N/A	127
--------	--------------	----------	--------	-------	-----	-----

- NOTES:**
- UNLESS OTHERWISE SPECIFIED ALL DIMENSIONS ARE NOMINAL.
 - ALL SPECIFICATIONS ARE SUBJECT TO CHANGE WITHOUT NOTICE AT ANY TIME.
 - DIMENSIONS ARE IN INCHES.
 - LENGTH TOLERANCE IS $\pm 1.5\%$ OR $\pm 3/8"$, WHICHEVER IS GREATER.