

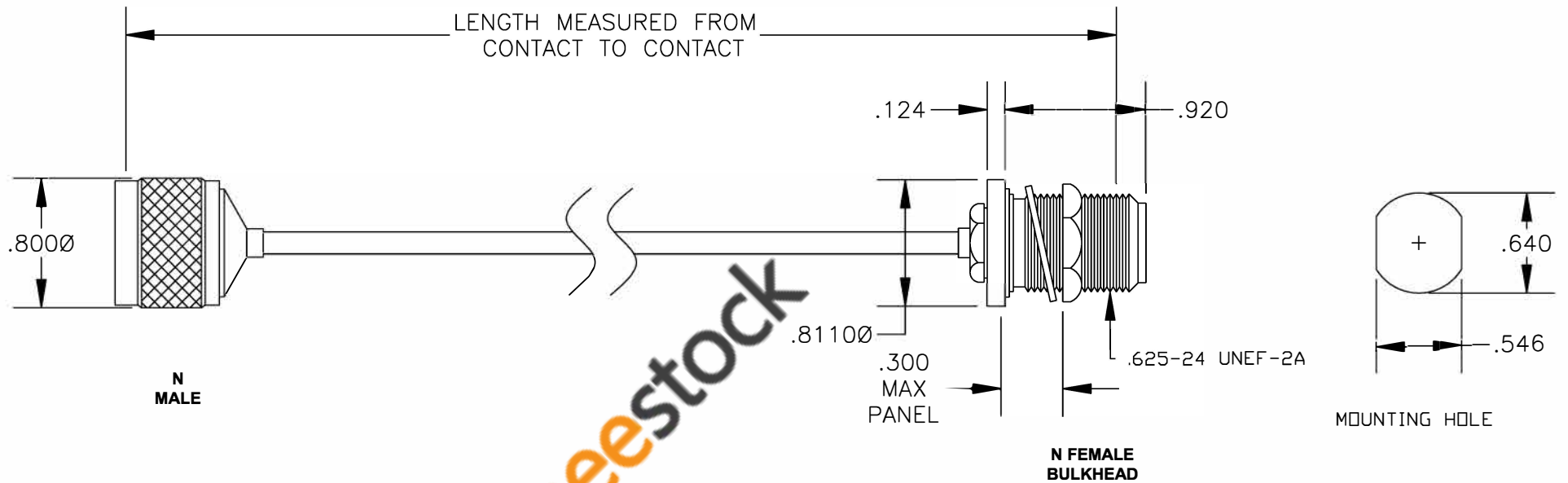

COMPONENTS	IMPEDANCE
N MALE	50 OHM
N FEMALE BULKHEAD	50 OHM
RG402/U	50 OHM

Standard Lengths	
-12	12"
-24	24"
-36	36"
-48	48"
-60	60"
-XXX	Custom Length in inches



RoHS
Compliance
Certified

 <p>8TH FLOOR, BUILDING 1, YONGFU SCIENCE AND TECHNOLOGY CENTER INDUSTRIAL PARK, NANZHA DISTRICT 5, HUMEN, 523900, DONGGUAN, GUANGDONG, CHINA</p> <p>WEBSITE: www.ebeestock.com EMAIL: sales@ebeestock.com COAXIAL & FIBER OPTICS</p>				
DWG TITLE	DES.			
ET279, 7	CABLE ASSEMBLY, RG402/U, N MALE TO N FEMALE BULKHEAD (LEAD FREE)			
REV. A	FSCM NO. 53919	CAD FILE 120708	SCALE N/A	SIZE A 127

NOTES:

1. UNLESS OTHERWISE SPECIFIED ALL DIMENSIONS ARE NOMINAL.
2. ALL SPECIFICATIONS ARE SUBJECT TO CHANGE WITHOUT NOTICE AT ANY TIME.
3. DIMENSIONS ARE IN INCHES.
4. LENGTH TOLERANCE IS $\pm 1.5\%$ OR $\pm 3/8"$, WHICHEVER IS GREATER.