

COMPONENTS	IMPEDANCE
N MALE	50 OHM
N FEMALE BULKHEAD	50 OHM
RG401/U	50 OHM

Standard Lengths	
-12	12"
-24	24"
-36	36"
-48	48"
-60	60"
-XXX	Custom Length in inches

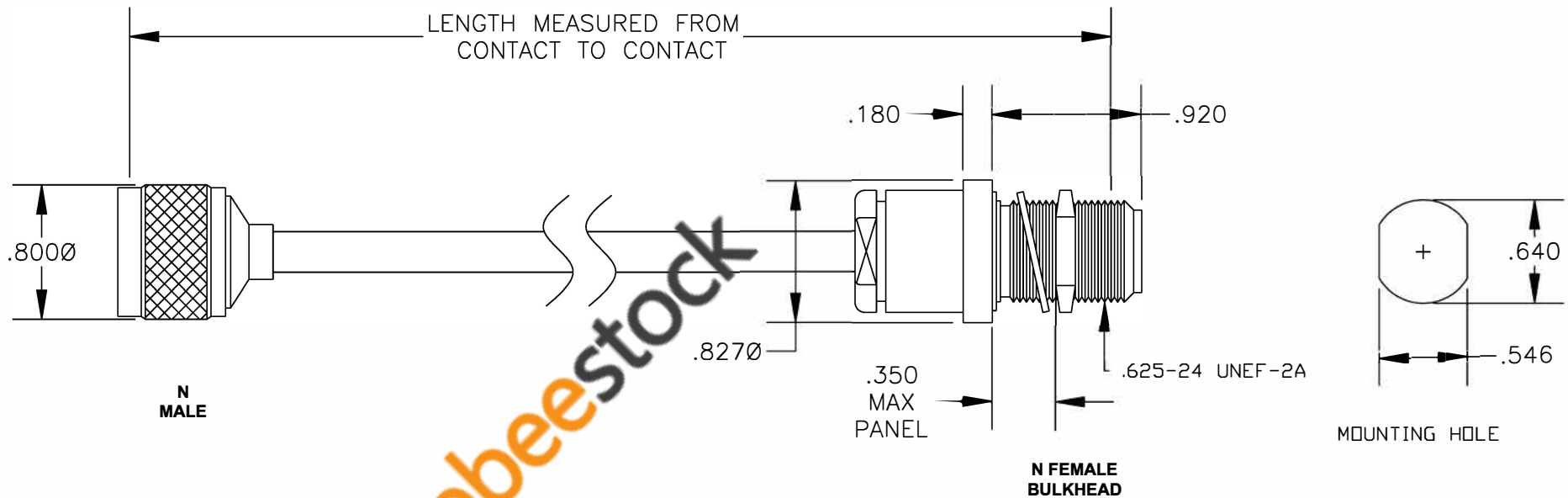

**8TH FLOOR, BUILDING 1, YONGFU SCIENCE AND TECHNOLOGY CENTER INDUSTRIAL PARK, NANZHA DISTRICT 5, HUMEN, 523900, DONGGUAN, GUANGDONG, CHINA**  
 WEBSITE: [www.ebeestock.com](http://www.ebeestock.com)  
 EMAIL: [sales@ebeestock.com](mailto:sales@ebeestock.com)  
**COAXIAL & FIBER OPTICS**

DWG TITLE <b>ET28263</b>		DES. CABLE ASSEMBLY, RG401/U, N MALE TO N FEMALE BULKHEAD		
REV. A	FSCM NO. 53919	CAD FILE 020108	SCALE N/A	SIZE A 127

- NOTES:**
- UNLESS OTHERWISE SPECIFIED ALL DIMENSIONS ARE NOMINAL.
  - ALL SPECIFICATIONS ARE SUBJECT TO CHANGE WITHOUT NOTICE AT ANY TIME.
  - DIMENSIONS ARE IN INCHES.
  - LENGTH TOLERANCE IS  $\pm 1.5\%$  OR  $\pm 3/8"$ , WHICHEVER IS GREATER.