

COMPONENTS	IMPEDANCE
SMB PLUG RIGHT ANGLE	50 OHM
SMB JACK BULKHEAD	50 OHM

Standard Lengths	
-12	12"
-24	24"
-36	36"
-48	48"
-60	60"
-XXX	Custom Length in inches

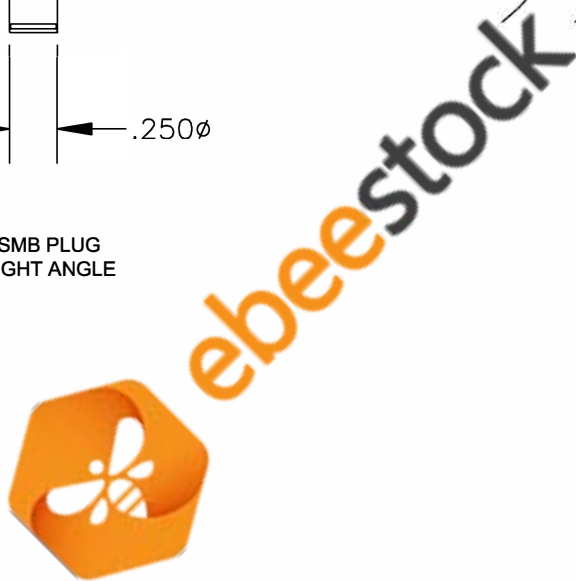
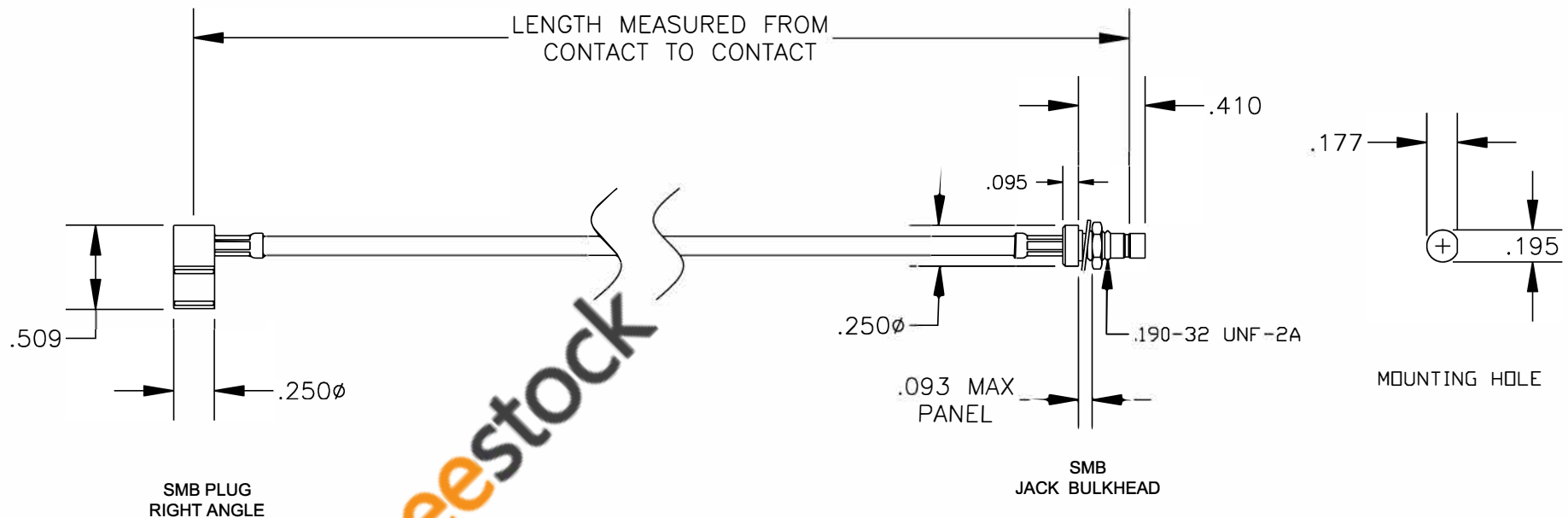

RoHS
Compliance
Certified

 8TH FLOOR, BUILDING 1, YONGFU SCIENCE AND TECHNOLOGY CENTER INDUSTRIAL PARK, NANZHA DISTRICT 5, HUMEN, 523900, DONGGUAN, GUANGDONG, CHINA

WEBSITE: www.ebeestock.com
EMAIL: sales@ebeestock.com

ET30341		DES. CABLE ASSEMBLY, RG316-DS, SMB PLUG RIGHT ANGLE TO SMB JACK BULKHEAD (LEAD FREE)		
REV. A	FSCM NO. 53919	CAD FILE 012208	SCALE N/A	SIZE A 147

- NOTES:
1. UNLESS OTHERWISE SPECIFIED ALL DIMENSIONS ARE NOMINAL.
 2. ALL SPECIFICATIONS ARE SUBJECT TO CHANGE WITHOUT NOTICE AT ANY TIME.
 3. DIMENSIONS ARE IN INCHES.
 4. LENGTH TOLERANCE IS $\pm 1.5\%$ OR $\pm 3/8"$, WHICHEVER IS GREATER.