

COMPONENTS

SMB PLUG
SMB JACK BULKHEAD -
ET38383

IMPEDANCE

50 OHM ~
50 OHM
50 OHM

Standard Lengths

-12	12"
-24	24"
-36	36"
-48	48"
-60	60"
-XXX	Custom Length in inches

LENGTH MEASURED FROM CONTACT TO CONTACT

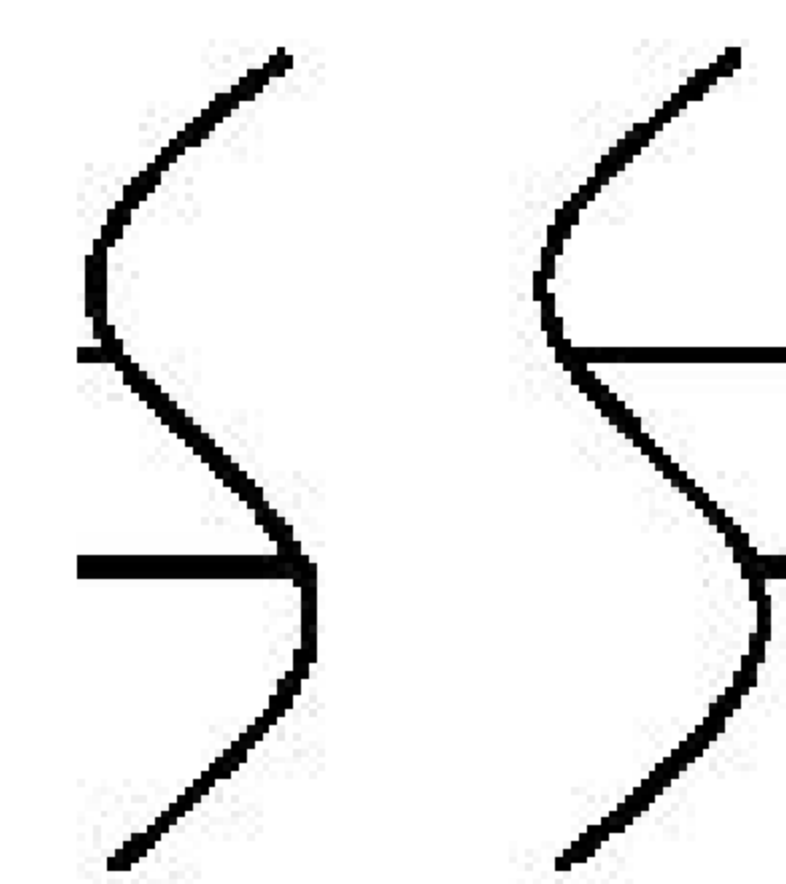
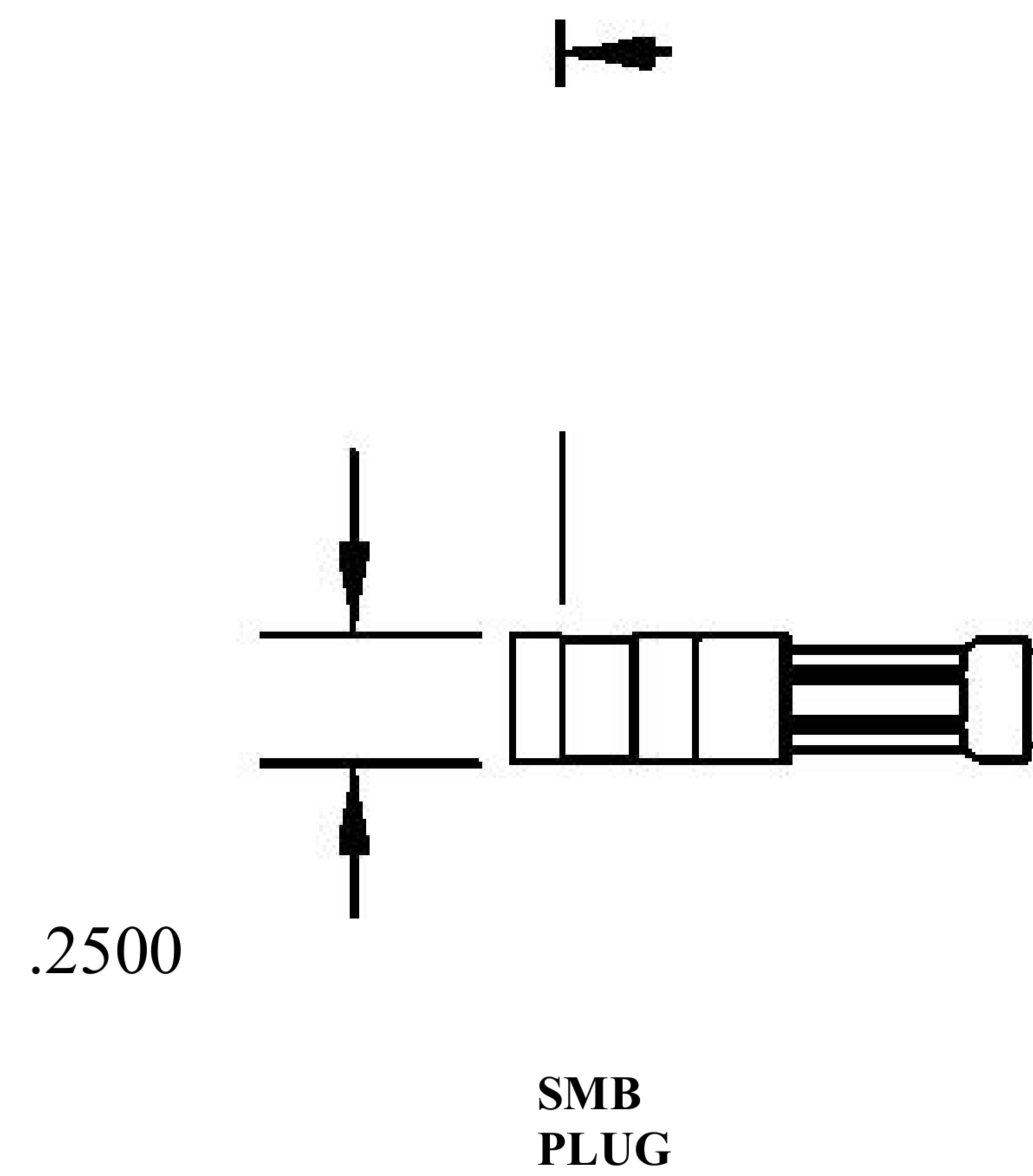

.250

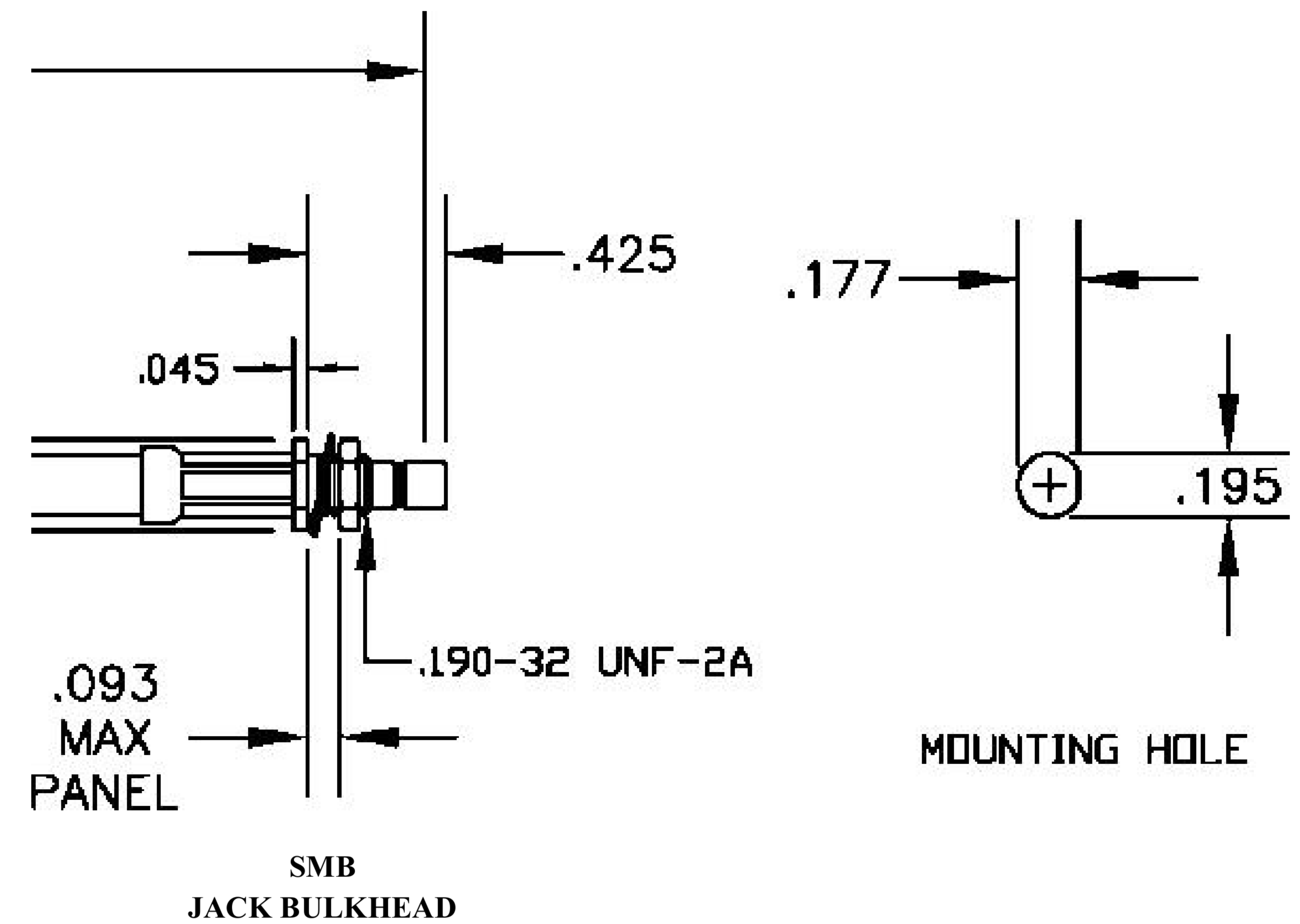

8th Floor, Building 1, Yongfu Science and Technology Center Industrial Park, Nanzha District 5, Humen, 523900, Dongguan, Guangdong, China.

Website: www.ebeestock.com

Email: sales@ebeestock.com

COAXIAL & FIBER OPTICS

DWG TITLE	ET30769	DES_	smb-plug-to-smb-jack-bulkhead-cable-12-inch-length-using-rg223-coax-0030768
-----------	---------	------	---

SIZE A | **FSCM NO. 53919** | CAD FILE 073102 | SCALE N/A | 127

NOTES:

1. UNLESS OTHERWISE SPECIFIED ALL DIMENSIONS ARE NOMINAL.
2. ALL SPECIFICATIONS ARE SUBJECT TO CHANGE WITHOUT NOTICE AT ANY TIME.