

COMPONENTS	IMPEDANCE
SMC PLUG	50 OHM
SMC JACK BULKHEAD	50 OHM
RG174A/U	50 OHM

Standard Lengths	
■12	12"
-24	24 ^H
-36	36"
■48	48"
-60	60"
■XXX	Custom Length in inches

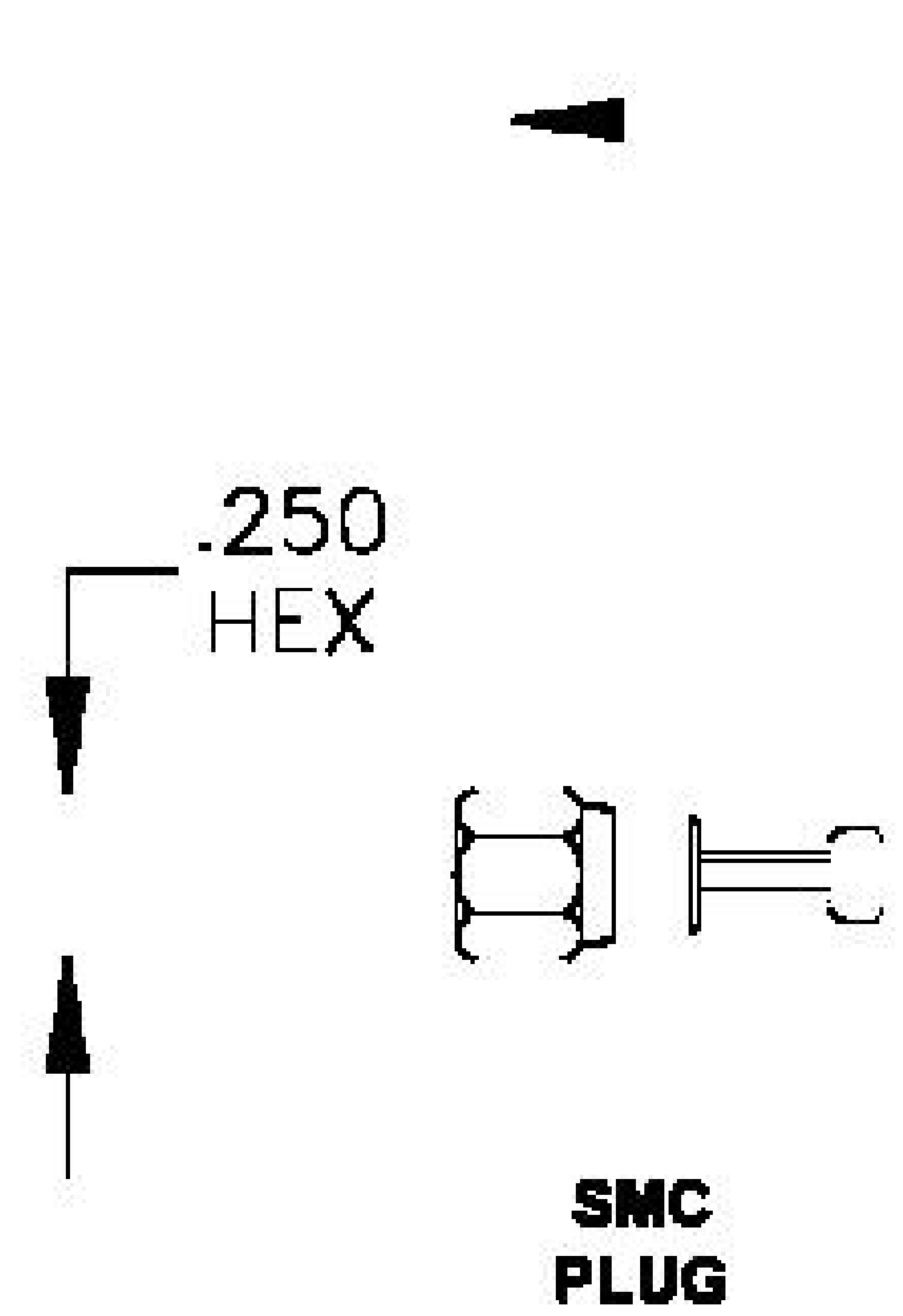

LENGTH MEASURED FROM
CONTACT TO CONTACT

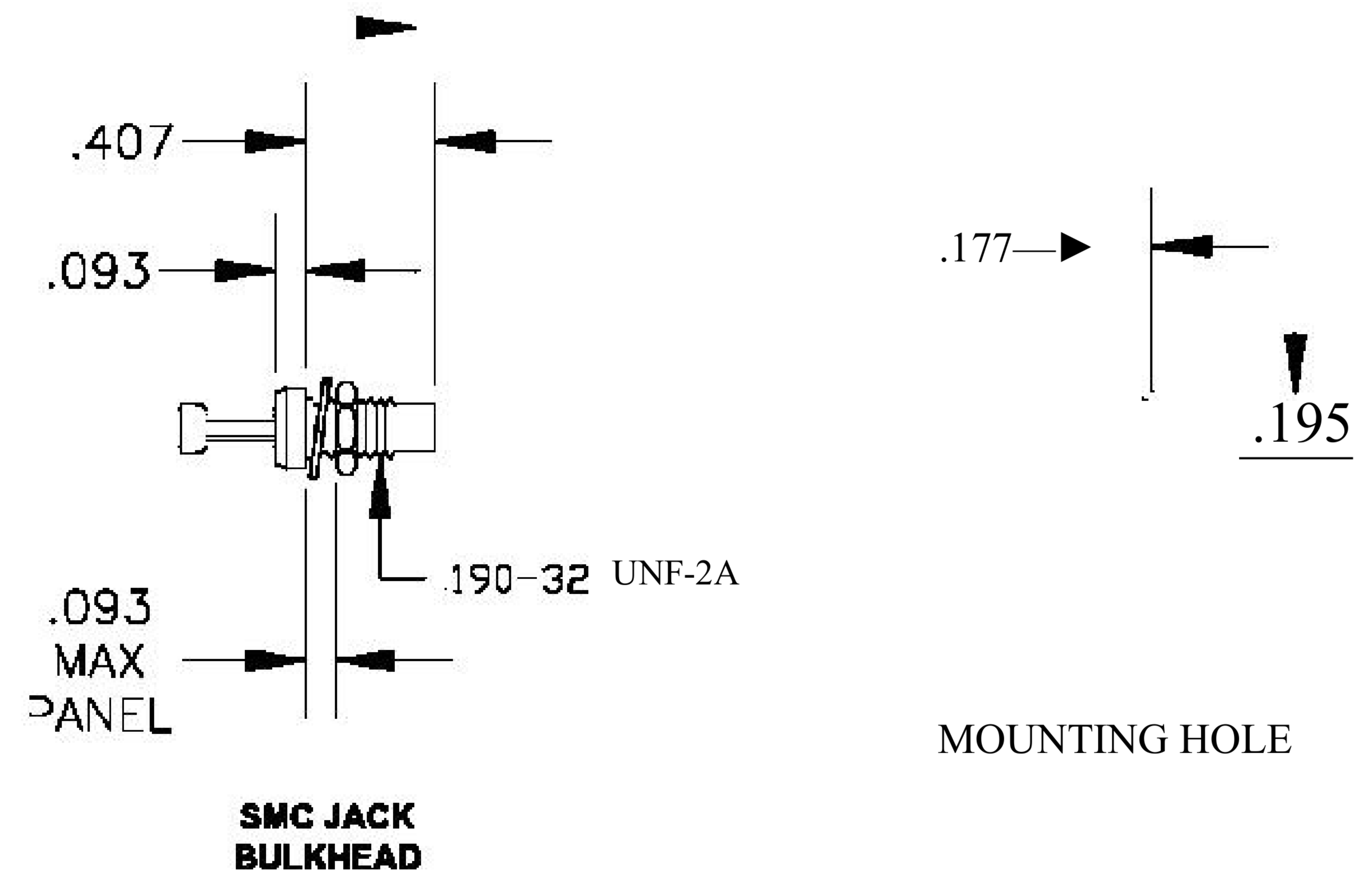
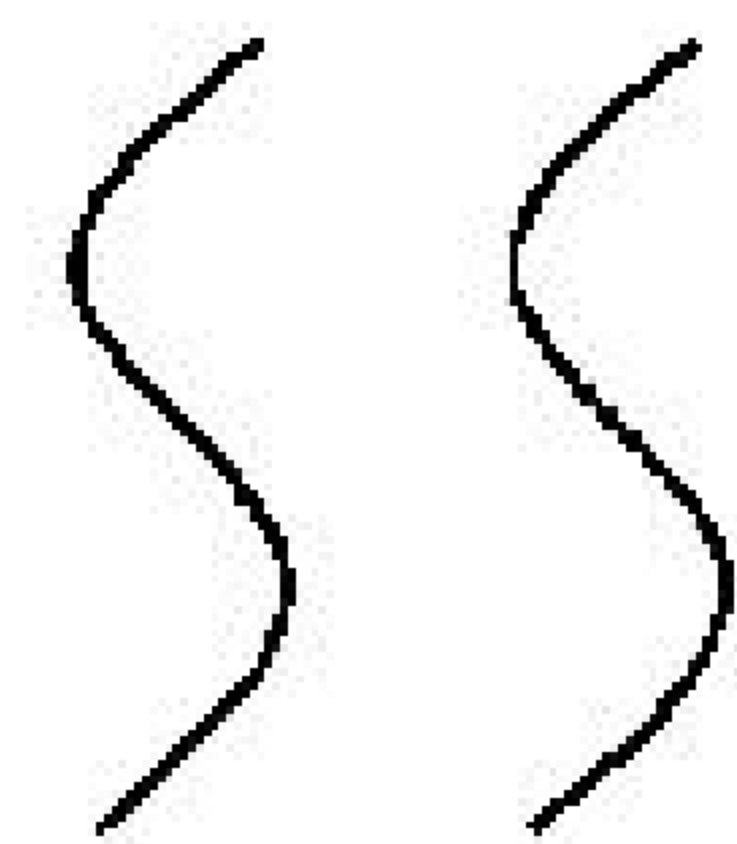

8th Floor, Building 1, Yongfu Science and Technology
Center Industrial Park, Nanzha District 5, Humen, 523900,
Dongguan, Guangdong, China.

Website: www.ebeestock.com

Email: sales@ebeestock.com

COAXIAL & FIBER OPTICS

DWG TITLE	ET31330	DES_	smc-plug-to-smc-jack-bulkhead-cable-12-inch-length-using-rg174-coax-ro hs-0031326
SIZE A FSCM NO. 53919 CAD FILE 073102 SCALE N/A			127

RoHS
Compliance
Certified

NOTES:

1. UNLESS OTHERWISE SPECIFIED ALL DIMENSIONS ARE NOMINAL.
2. ALL SPECIFICATIONS ARE SUBJECT TO CHANGE WITHOUT NOTICE AT ANY TIME.