

COMPONENTS	IMPEDANCE
SMC PLUG	50 OHM
SMC JACK BULKHEAD	50 OHM
RG142B/U	50 OHM

Standard Lengths	
-12	12"
-24	24"
-36	36"
-48	48"
-60	60"
-XXX	Custom Length in inches

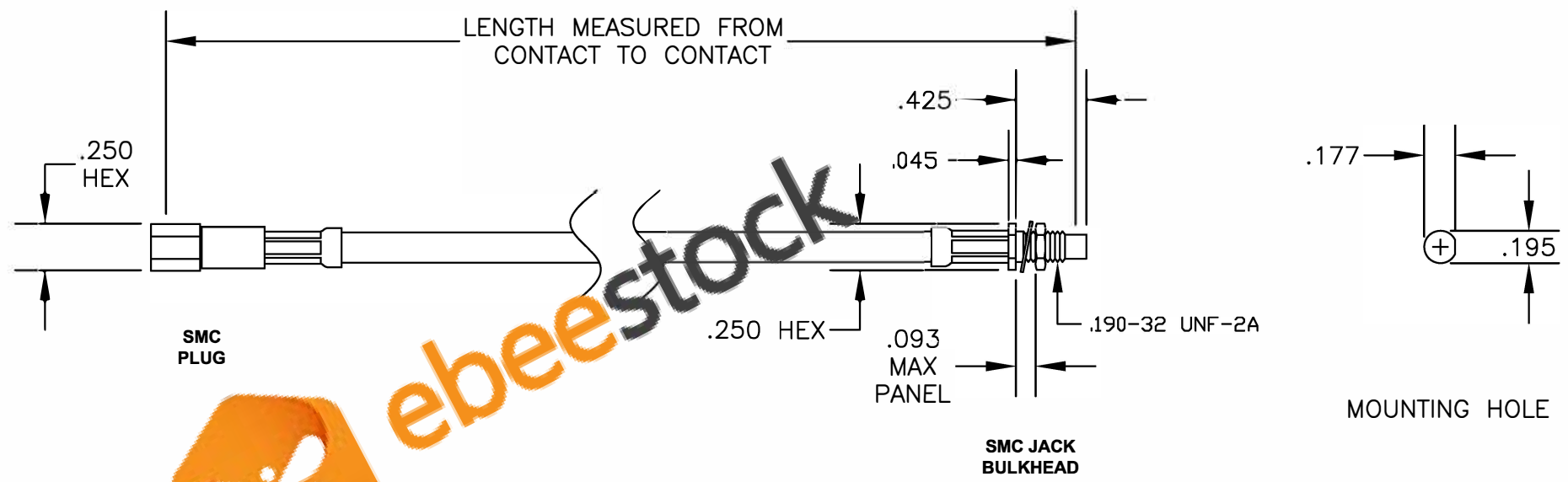

**8TH FLOOR, BUILDING 1, YONGFU SCIENCE AND TECHNOLOGY CENTER INDUSTRIAL PARK, NANZHA DISTRICT 5, HUMEN, 523900, DONGGUAN, GUANGDONG, CHINA**  
 WEBSITE: [www.ebeeestock.com](http://www.ebeeestock.com)  
 EMAIL: [sales@ebeeestock.com](mailto:sales@ebeeestock.com)

<b>ET31575</b>	DES. CABLE ASSEMBLY, RG142B/U, SMC PLUG TO SMC JACK BULKHEAD
CAD FILE 030107	SCALE N/A
	127

1. UNLESS OTHERWISE SPECIFIED ALL DIMENSIONS ARE NOMINAL.
2. ALL SPECIFICATIONS ARE SUBJECT TO CHANGE WITHOUT NOTICE AT ANY TIME.
3. DIMENSIONS ARE IN INCHES.
4. LENGTH TOLERANCE IS  $\pm 1.5\%$  OR  $\pm 3/8"$ , WHICHEVER IS GREATER.