

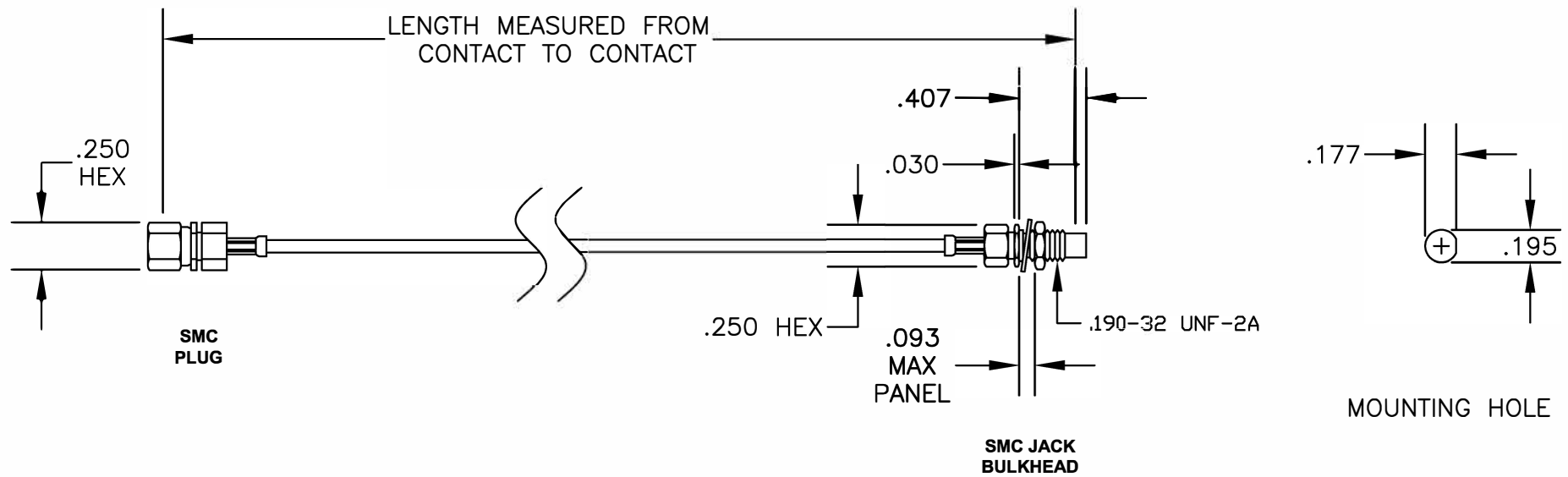

COMPONENTS	IMPEDANCE
SMC PLUG	50 OHM
SMC JACK BULKHEAD	50 OHM
RG196A/U	50 OHM

Standard Lengths	
-12	12"
-24	24"
-36	36"
-48	48"
-60	60"
-XXX	Custom Length in inches





8TH FLOOR, BUILDING 1, YONGFU SCIENCE AND TECHNOLOGY CENTER INDUSTRIAL PARK, NANZHA DISTRICT 5, HUMEN, 523900, DONGGUAN, GUANGDONG, CHINA

WEBSITE: [www.ebeestock.com](http://www.ebeestock.com)  
EMAIL: [sales@ebeestock.com](mailto:sales@ebeestock.com)

DWG TITLE <h2 style="margin: 0;">ET31898</h2>	DES. CABLE ASSEMBLY, RG196A/U, SMC PLUG TO SMC JACK BULKHEAD
SIZE A   <b>FSCMNO. 53919</b>	CAD FILE 030107    SCALE N/A    127
<b>NOTES:</b> 1. UNLESS OTHERWISE SPECIFIED ALL DIMENSIONS ARE NOMINAL. 2. ALL SPECIFICATIONS ARE SUBJECT TO CHANGE WITHOUT NOTICE AT ANY TIME. 3. DIMENSIONS ARE IN INCHES. 4. LENGTH TOLERANCE IS $\pm 1.5\%$ OR $\pm 3/8"$ , WHICHEVER IS GREATER.	