

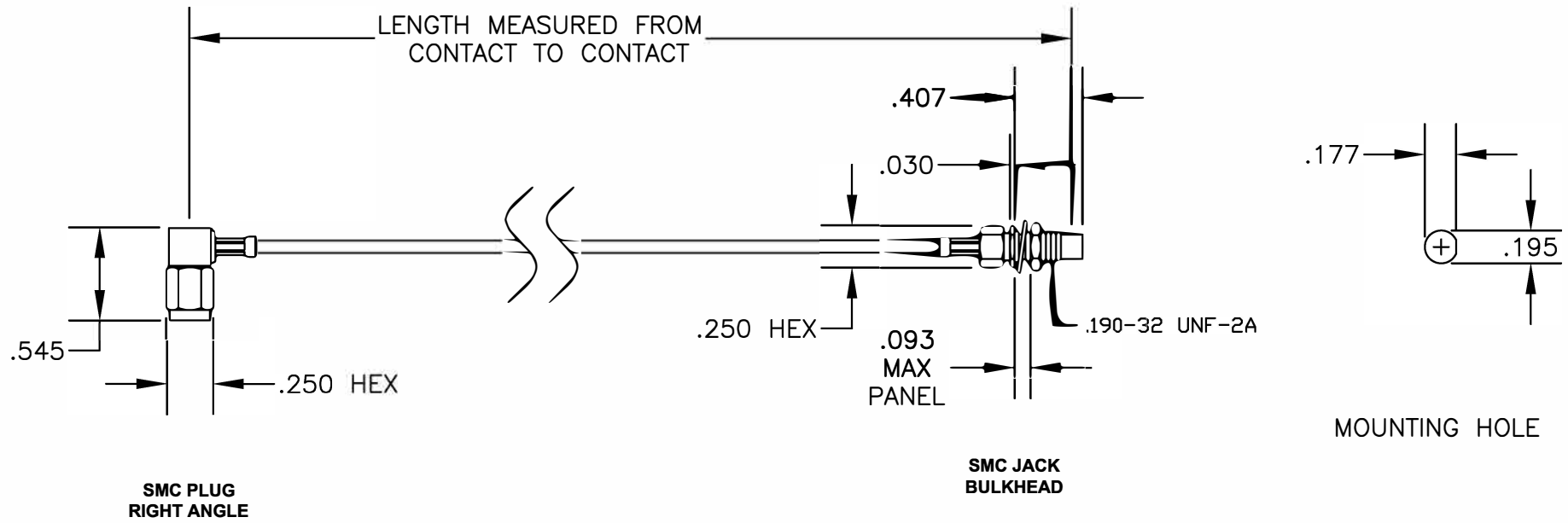

COMPONENTS	IMPEDANCE
SMC PLUG RIGHT ANGLE	50 OHM
SMC JACK BULKHEAD	50 OHM
RG196A/U	50 OHM

Standard Lengths	
-12	12"
-24	24"
-36	36"
-48	48"
-60	60"
-XXX	Custom Length in inches





8TH FLOOR, BUILDING 1, YONGFU SCIENCE AND TECHNOLOGY CENTER INDUSTRIAL PARK, NANZHA DISTRICT 5, HUMEN, 523900, DONGGUAN, GUANGDONG, CHINA

WEBSITE: www.ebeestock.com
EMAIL: sales@ebeestock.com

DWG TITLE		DES.			
ET31926		CABLE ASSEMBLY, RG196A/U, SMC PLUG RIGHT ANGLE TO SMC JACK BULKHEAD (LEAD FREE)			
SIZE A	FSCM NO. 53919	CAD FILE	042109	SCALE	N/A
					127

NOTES:

- UNLESS OTHERWISE SPECIFIED ALL DIMENSIONS ARE NOMINAL.
- ALL SPECIFICATIONS ARE SUBJECT TO CHANGE WITHOUT NOTICE AT ANY TIME.
- DIMENSIONS ARE IN INCHES.
- LENGTH TOLERANCE IS $\pm 1.5\%$ OR $\pm 3/8"$, WHICHEVER IS GREATER.