

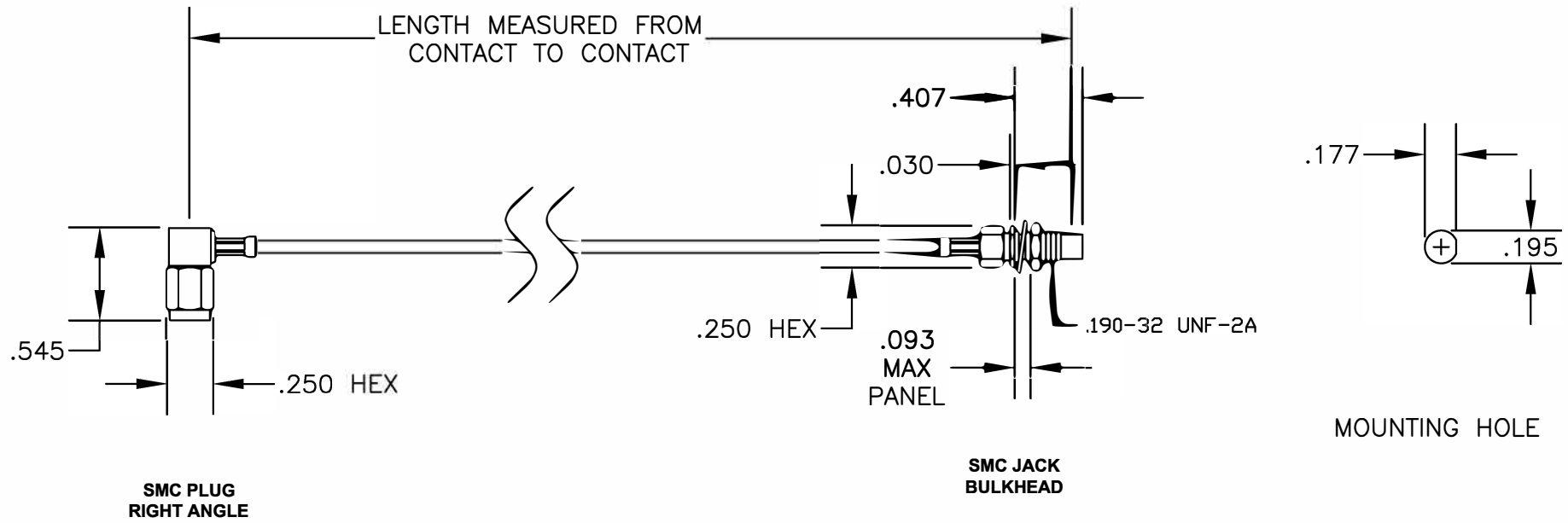

COMPONENTS	IMPEDANCE
SMC PLUG RIGHT ANGLE	50 OHM
SMC JACK BULKHEAD	50 OHM
RG178B/U	50 OHM

Standard Lengths	
-12	12"
-24	24"
-36	36"
-48	48"
-60	60"
-XXX	Custom Length in inches





8TH FLOOR, BUILDING 1, YONGFU SCIENCE AND TECHNOLOGY CENTER INDUSTRIAL PARK, NANZHA DISTRICT 5, HUMEN, 523900, DONGGUAN, GUANGDONG, CHINA

WEBSITE: www.ebeestock.com
EMAIL: sales@ebeestock.com

DWG TITLE <h2 style="text-align: center; margin: 0;">ET32033</h2>	DES. CABLE ASSEMBLY, RG178B/U, SMC PLUG RIGHT ANGLE TO SMC JACK BULKHEAD
SIZE A FSCM NO. 53919	CAD FILE 042109 SCALE N/A 127
NOTES: 1. UNLESS OTHERWISE SPECIFIED ALL DIMENSIONS ARE NOMINAL. 2. ALL SPECIFICATIONS ARE SUBJECT TO CHANGE WITHOUT NOTICE AT ANY TIME. 3. DIMENSIONS ARE IN INCHES. 4. LENGTH TOLERANCE IS ± 1.5% OR ±3/8", WHICHEVER IS GREATER.	