

SMA Male to SMC Plug Cable 36 Inch Length Using RG174 Coax

REVISIONS			
REV.	DESCRIPTION	DATE	APPROVED
A	INITIAL RELEASE	8/25/2020	S.ELLIS

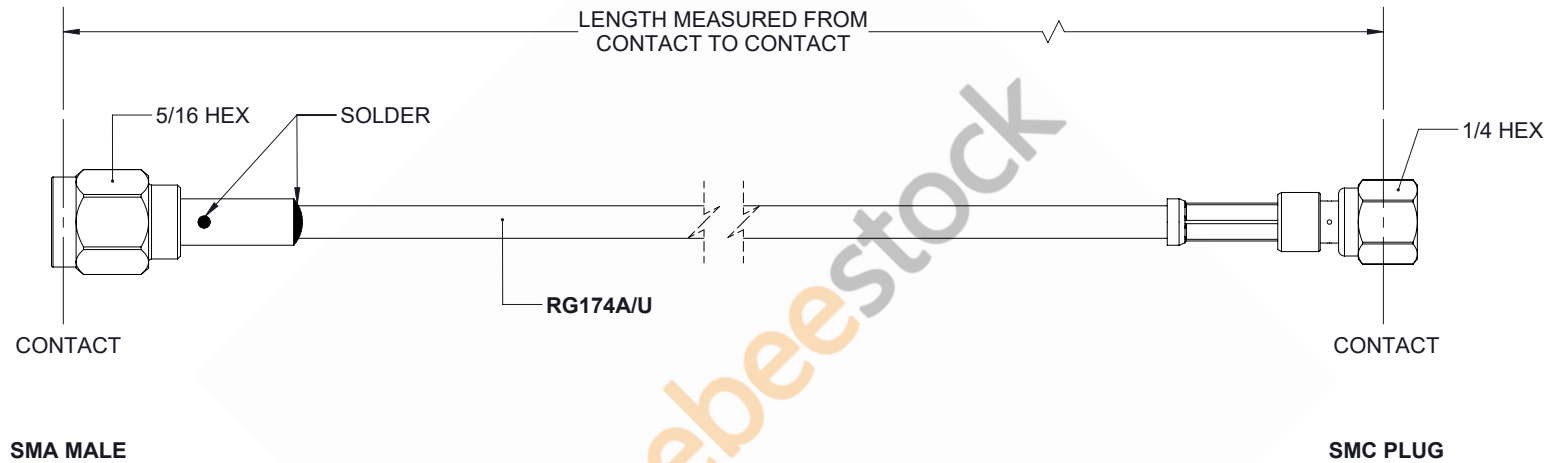

UNLESS OTHERWISE SPECIFIED
LEADING DIMENSIONS ARE INCHES
DIMENSIONS IN [] ARE MILLIMETERS

TOLERANCES:

.X = ±.2	[.508]	FRACTIONS
.XX = ±.02	[.51]	± 1/32
.XXX = ±.005	[.13]	ANGLES ± 1°

CABLE LENGTH (L) TOLERANCES:

L ≤ 12	[305]	= +1	[25]	/ -0
12 [305] < L ≤ 60	[1524]	= +2	[51]	/ -0
60 [1524] < L ≤ 120	[3048]	= +4	[102]	/ -0
120 [3048] < L ≤ 300	[7620]	= +6	[152]	/ -0
300 [7620] < L		= +5%	L	/ -0

ALL DIMENSIONS SHOWN
ARE FOR REFERENCE ONLY.



8TH FLOOR, BUILDING 1,
YONGFU SCIENCE AND TECHNOLOGY
CENTER INDUSTRIAL PARK, NANZHA DISTRICT
5, HUMEN, 523900, DONGGUAN, GUANGDONG, CHINA

WEBSITE: www.ebeestock.com
EMAIL: sales@ebeestock.com

THIRD-ANGLE PROJECTION

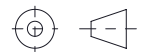

THE INFORMATION AND
DESIGN IN THIS DOCUMENT
IS THE PROPERTY OF
EBEESTOCK CORPORATION
ALL RIGHTS RESERVED.

SHEET 1 OF 1

SCALE N/A

THESE COMMODITIES, TECHNOLOGY OR SOFTWARE WERE EXPORTED FROM THE UNITED STATES IN ACCORDANCE WITH THE EXPORT ADMINISTRATION REGULATIONS. DIVERSION CONTRARY TO U.S. LAW PROHIBITED.

SIZE	CAGE CODE	DRAWN BY	ITEM NO.	REV
A	53919	K.DANG	ET32186	A