

# SMA Male to SMC Plug Cable 100 cm Length Using RG174 Coax

REVISIONS			
REV.	DESCRIPTION	DATE	APPROVED
A	INITIAL RELEASE	8/25/2020	S.ELLIS

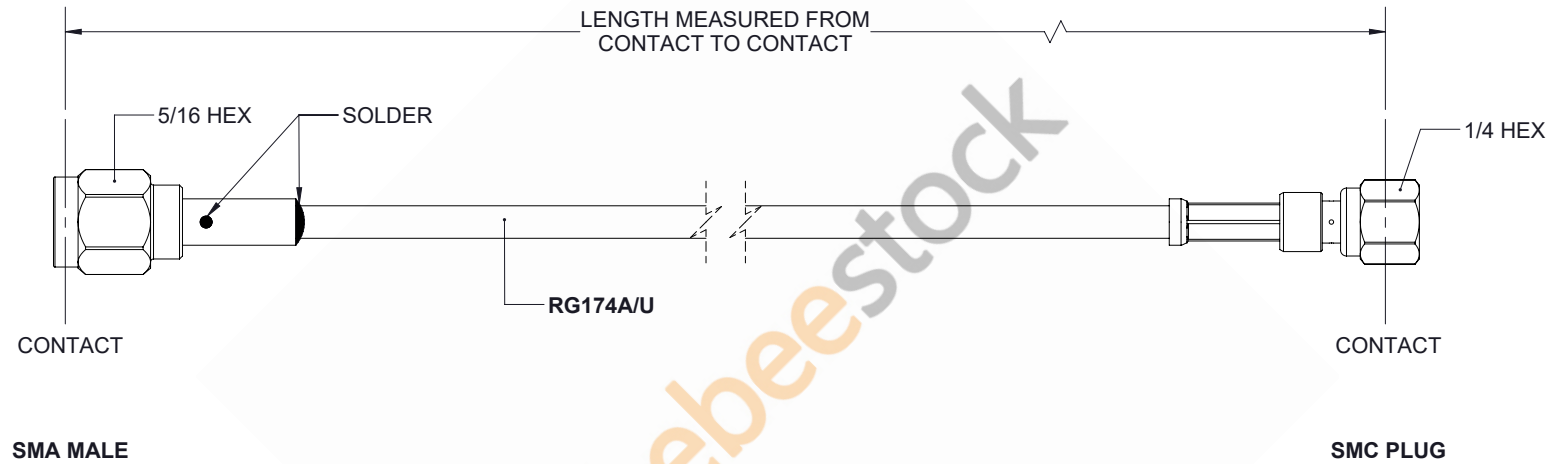

UNLESS OTHERWISE SPECIFIED  
LEADING DIMENSIONS ARE INCHES  
DIMENSIONS IN [ ] ARE MILLIMETERS

**TOLERANCES:**

.X = ±.2	[.508]	FRACTIONS
.XX = ±.02	[.51]	± 1/32
.XXX = ±.005	[.13]	ANGLES ± 1°

**CABLE LENGTH (L) TOLERANCES:**

L ≤ 12	[305]	= +1	[25]	/ -0
12 [305]	< L ≤ 60	[1524]	= +2	[51] / -0
60 [1524]	< L ≤ 120	[3048]	= +4	[102] / -0
120 [3048]	< L ≤ 300	[7620]	= +6	[152] / -0
300 [7620]	< L	= +5%	L	/ -0

ALL DIMENSIONS SHOWN  
ARE FOR REFERENCE ONLY.



8TH FLOOR, BUILDING 1,  
YONGFU SCIENCE AND TECHNOLOGY  
CENTER INDUSTRIAL PARK, NANZHA DISTRICT  
5, HUMEN, 523900, DONGGUAN, GUANGDONG, CHINA

WEBSITE: [www.ebeestock.com](http://www.ebeestock.com)  
EMAIL: [sales@ebeestock.com](mailto:sales@ebeestock.com)

**THIRD-ANGLE PROJECTION**

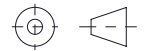

THE INFORMATION AND  
DESIGN IN THIS DOCUMENT  
IS THE PROPERTY OF  
EBEESTOCK CORPORATION  
ALL RIGHTS RESERVED.

SHEET 1 OF 1

SCALE N/A

THESE COMMODITIES, TECHNOLOGY OR SOFTWARE WERE EXPORTED FROM THE UNITED STATES IN ACCORDANCE WITH THE EXPORT ADMINISTRATION REGULATIONS. DIVERSION CONTRARY TO U.S. LAW PROHIBITED.

SIZE	CAGE CODE	DRAWN BY	ITEM NO.	REV
A	53919	K.DANG	ET32190	A