

Push-On SMP Female to SMA Male Cable 200 cm Length Using Coax with HeatShrink

REVISIONS			
REV.	DESCRIPTION	DATE	APPROVED
A	INITIAL RELEASE	04/23/19	S.ELLIS

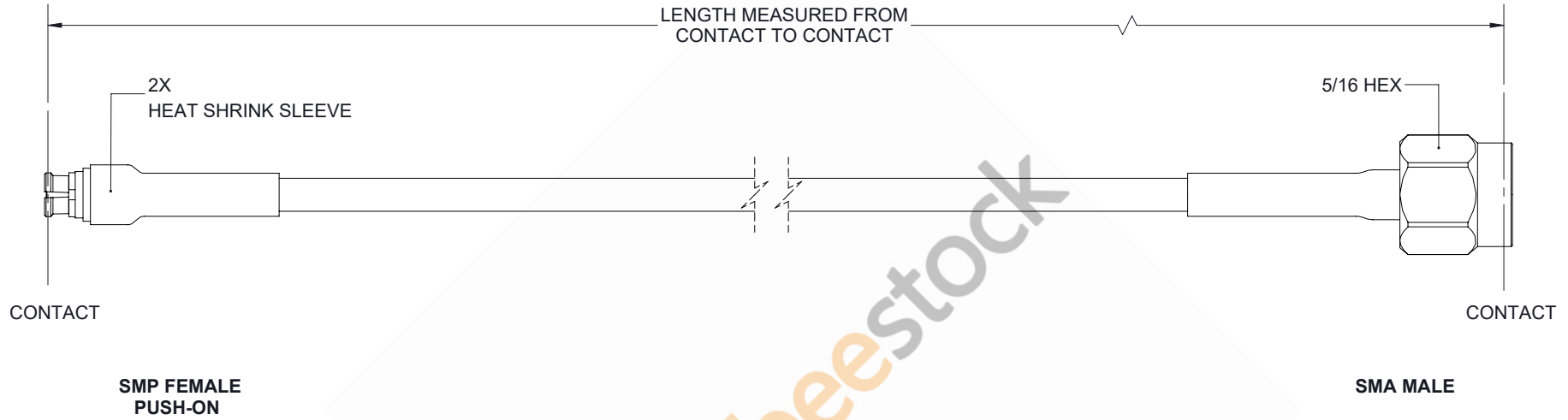

ebeestock

UNLESS OTHERWISE SPECIFIED LEADING DIMENSIONS ARE INCHES DIMENSIONS IN [] ARE MILLIMETERS		 8TH FLOOR, BUILDING 1, YONGFU SCIENCE AND TECHNOLOGY CENTER INDUSTRIAL PARK, NANZHA DISTRICT 5,HUMEN,523900,DONGGUAN, GUANGDONG, CHINA WEBSITE: www.ebeestock.com EMAIL: sales@ebeestock.com		THE INFORMATION AND DESIGN IN THIS DOCUMENT IS THE PROPERTY OF EBEESTOCK CORPORATION. ALL RIGHTS RESERVED.	
TOLERANCES: .X±.2 [5.08] FRACTIONS ± 1/32 .XX±.01 [.25] ANGLES ± 1° .XXX±.005 [.13]				SHEET 1 OF 1	
ALL DIMENSIONS SHOWN ARE FOR REFERENCE ONLY.		SCALE N/A			
THIRD-ANGLE PROJECTION 		SIZE A CAGE 53919 DRAWN BY K.DANG PART NUMBER ET32347 REV A			

THESE COMMODITIES, TECHNOLOGY OR SOFTWARE WERE EXPORTED FROM THE UNITED STATES IN ACCORDANCE WITH THE EXPORT ADMINISTRATION REGULATIONS. DIVERSION CONTRARY TO U.S. LAW PROHIBITED.