

SSMC Plug Right Angle to SSMC Plug Right
Angle Cable 36 Inch Length Using RG178 Coax

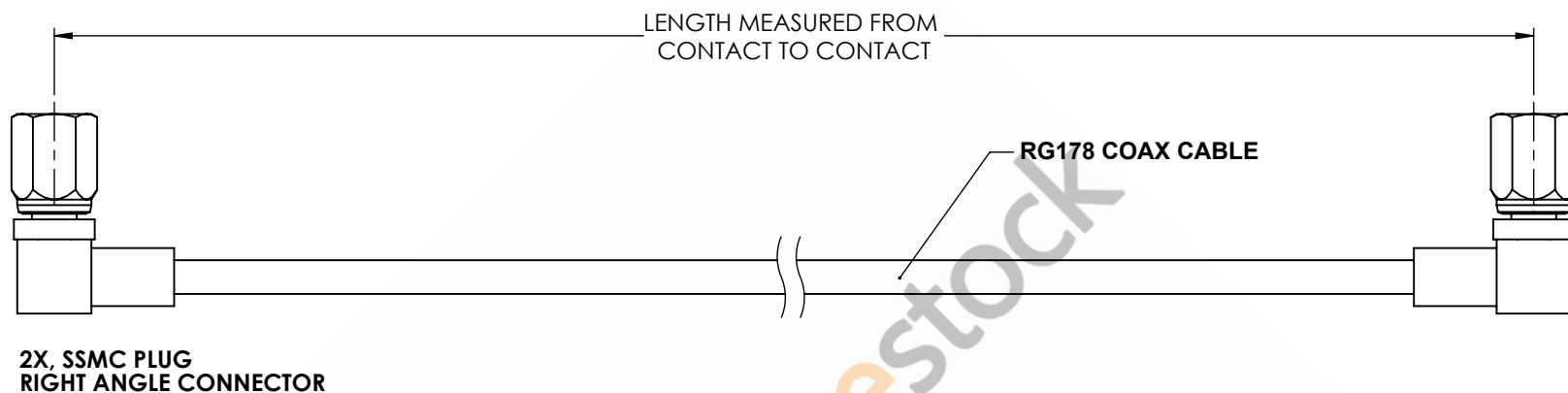

STANDARD TOLERANCES

.X	±0.2
.XX	±0.01
.XXX	±0.005

*STANDARD TOLERANCES APPLY ONLY TO DIMENSIONS IN INCHES



8TH FLOOR, BUILDING 1,
YONGFU SCIENCE AND TECHNOLOGY
CENTER INDUSTRIAL PARK, NANZHA DISTRICT
5, HUMEN, 523900, DONGGUAN, GUANGDONG, CHINA

WEBSITE: www.ebeestock.com
EMAIL: sales@ebeestock.com

DWG TITLE

ET32925

NOTES:

1. UNLESS OTHERWISE SPECIFIED ALL DIMENSIONS ARE NOMINAL.
2. ALL SPECIFICATIONS ARE SUBJECT TO CHANGE WITHOUT NOTICE AT ANY TIME
3. DIMENSIONS ARE IN INCHES [mm].

CAGE CODE 53919

CAD FILE 08/31/17

SCALE N/A

SIZE A

CN2245