

TNC Male Right Angle to TNC Female Bulkhead Cable 24 Inch Length Using LMR-195 Coax

REVISIONS			
REV.	DESCRIPTION	DATE	APPROVED
A	INITIAL RELEASE	8/20/2020	S.ELLIS

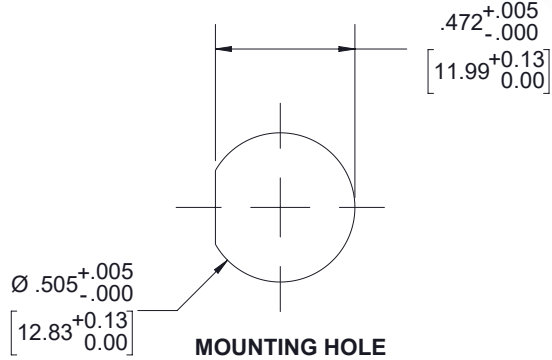
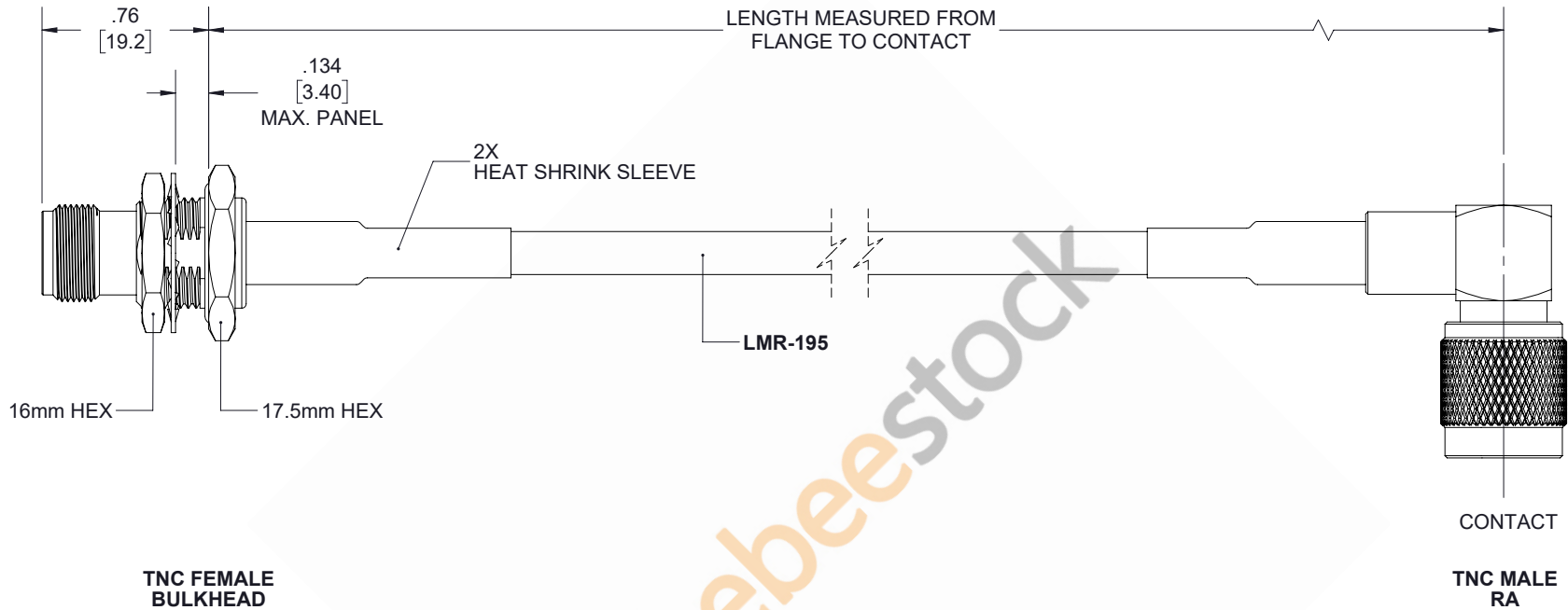

UNLESS OTHERWISE SPECIFIED
LEADING DIMENSIONS ARE INCHES
DIMENSIONS IN [] ARE MILLIMETERS

TOLERANCES:

.X = ±.2 [5.08]	FRACTIONS
.XX = ±.02 [51]	± 1/32
.XXX = ±.005 [.13]	ANGLES ± 1°

CABLE LENGTH (L) TOLERANCES:

L ≤ 12 [305]	= +1 [25] / -0
12 [305] < L ≤ 60 [1524]	= +2 [51] / -0
60 [1524] < L ≤ 120 [3048]	= +4 [102] / -0
120 [3048] < L ≤ 300 [7620]	= +6 [152] / -0
300 [7620] < L	= +5%L / -0

ALL DIMENSIONS SHOWN
ARE FOR REFERENCE ONLY.



8TH FLOOR, BUILDING 1,
YONGFU SCIENCE AND TECHNOLOGY
CENTER INDUSTRIAL PARK, NANZHA DISTRICT
5, HUMEN, 523900, DONGGUAN, GUANGDONG, CHINA

WEBSITE: www.ebeestock.com
EMAIL: sales@ebeestock.com

THIRD-ANGLE PROJECTION

THE INFORMATION AND
DESIGN IN THIS DOCUMENT
IS THE PROPERTY OF
PASTERNAK CORPORATION
ALL RIGHTS RESERVED.

SHEET 1 OF 1

SCALE N/A

SIZE	CAGE CODE	DRAWN BY	ITEM NO.	REV
A	53919	K.DANG	ET33526	A