

TNC Male to TNC Male Low Loss Cable 60 Inch Length Using Coax

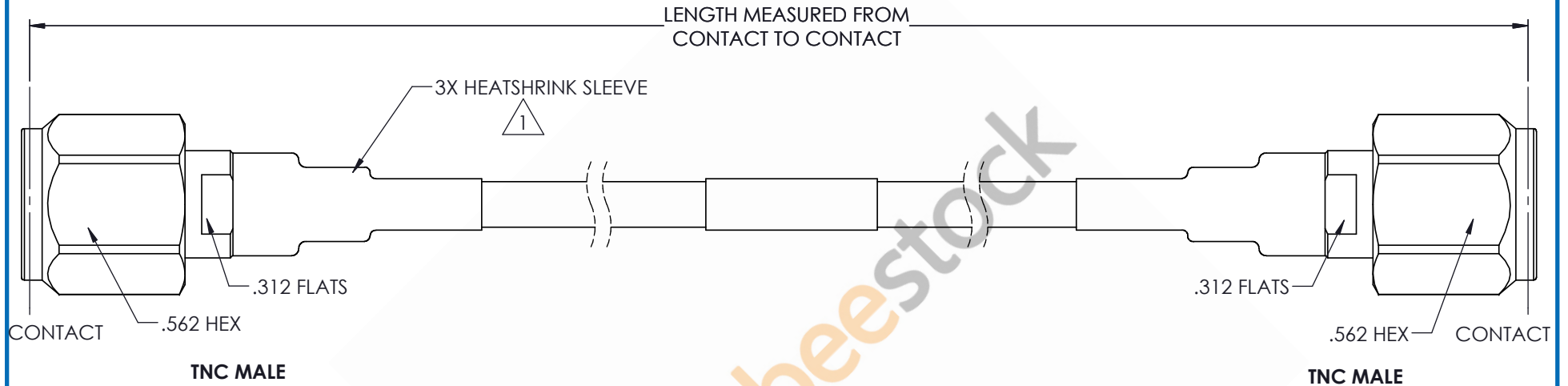

NOTES:

1. BLACK HEAT SHRINK WITH WHITE MARKINGS 3 PLACES.

STANDARD TOLERANCES	
.X	±0.2
.XX	±0.01
.XXX	±0.005

*STANDARD TOLERANCES APPLY ONLY TO DIMENSIONS IN INCHES



8TH FLOOR, BUILDING 1, YONGFU SCIENCE AND TECHNOLOGY
CENTER INDUSTRIAL PARK, NANZHA DISTRICT 5,
HUMEN, 523900, DONGGUAN, GUANGDONG, CHINA

WEBSITE: www.ebeestock.com
EMAIL: sales@ebeestock.com

ebeestock

DWG TITLE

ET33556

NOTES:

1. UNLESS OTHERWISE SPECIFIED ALL DIMENSIONS ARE NOMINAL.
2. ALL SPECIFICATIONS ARE SUBJECT TO CHANGE WITHOUT NOTICE AT ANY TIME.
3. DIMENSIONS ARE IN INCHES [mm].

CAGE CODE 53919

CAD FILE 07/12/18

SCALE N/A

SIZE A

CN2379