

# TNC Male to TNC Male Flexible Cable 200 CM Length Using RG174 Coax

REVISIONS			
REV.	DESCRIPTION	DATE	APPROVED
A	INITIAL RELEASE	4/14/2021	S.ELLIS

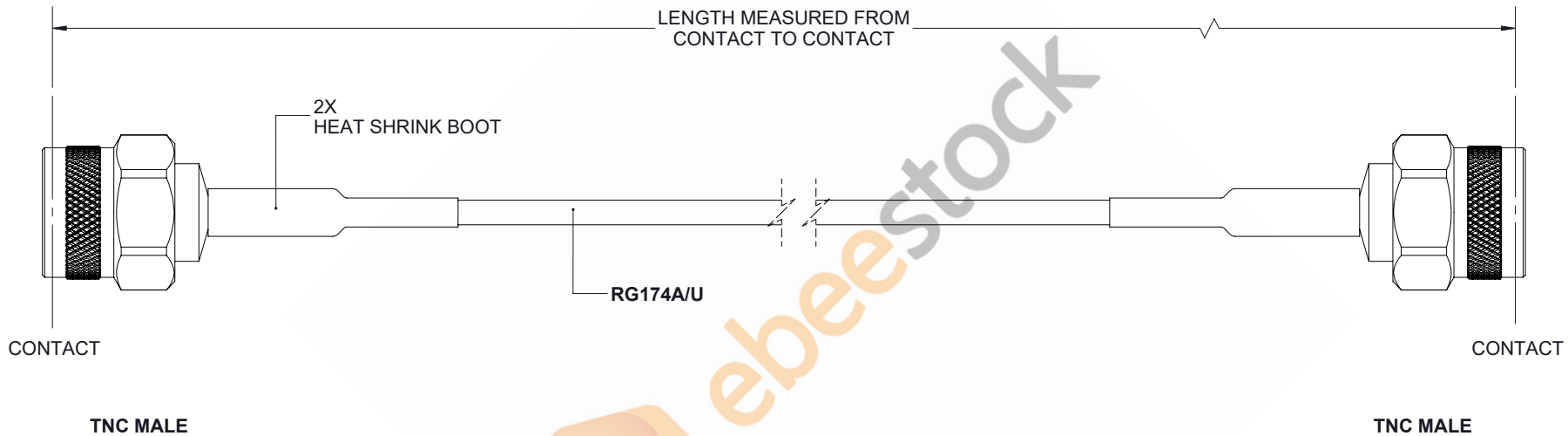

UNLESS OTHERWISE SPECIFIED  
LEADING DIMENSIONS ARE INCHES  
DIMENSIONS IN [ ] ARE MILLIMETERS

**TOLERANCES:**

.X = ±.2	[.508]	FRACTIONS
.XX = ±.02	[.51]	± 1/32
.XXX = ±.005	[.13]	ANGLES ± 1°

**CABLE LENGTH (L) TOLERANCES:**

L ≤ 12	[305]	= +1	[25]	/ -0
12 [305]	< L ≤ 60	[1524]	= +2	[51] / -0
60 [1524]	< L ≤ 120	[3048]	= +4	[102] / -0
120 [3048]	< L ≤ 300	[7620]	= +6	[152] / -0
300 [7620]	< L =	+5%	L	/ -0

ALL DIMENSIONS SHOWN  
ARE FOR REFERENCE ONLY.



8TH FLOOR, BUILDING 1,  
YONGFU SCIENCE AND TECHNOLOGY  
CENTER INDUSTRIAL PARK, NANZHA DISTRICT  
5, HUMEN, 523900, DONGGUAN, GUANGDONG, CHINA

WEBSITE: [www.ebeestock.com](http://www.ebeestock.com)  
EMAIL: [sales@ebeestock.com](mailto:sales@ebeestock.com)

THIRD-ANGLE PROJECTION

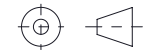

THE INFORMATION AND  
DESIGN IN THIS DOCUMENT  
IS THE PROPERTY OF  
PASTERNAK CORPORATION  
ALL RIGHTS RESERVED.

SHEET 1 OF 1

SCALE N/A

SIZE	CAGE CODE	DRAWN BY	ITEM NO.	REV
A	53919	K.DANG	ET33605	A