

COMPONENTS	IMPEDANCE
UMCX PLUG	50 OHM
REVERSE POLARITY MCX JACK BULKHEAD	50 OHM
RG178B/U	50 OHM

Standard Lengths	
-3	3"
-6	6"
-9	9"
-12	12"
-18	18"
-24	24"
-XXX	Custom Length in inches (24" Max Length)

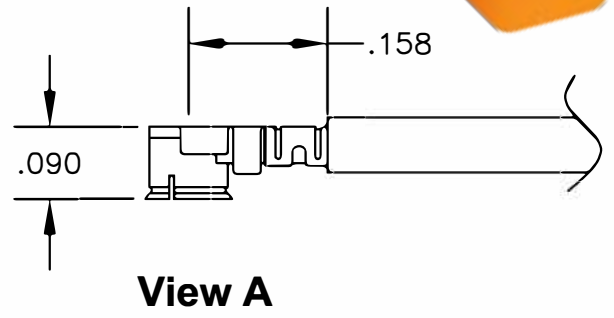
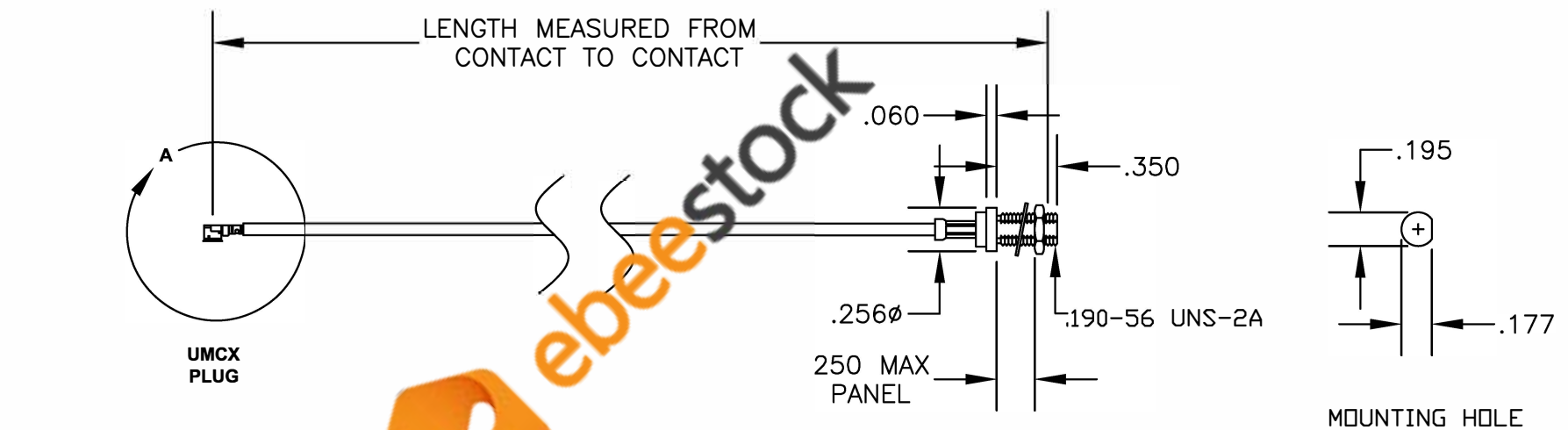

 8TH FLOOR, BUILDING 1, YONGFU SCIENCE AND TECHNOLOGY CENTER INDUSTRIAL PARK, NANZHA DISTRICT 5, HUMEN, 523900, DONGGUAN, GUANGDONG, CHINA

ebeestock
ESTABLISHED 2003

WEBSITE: www.ebeestock.com
EMAIL: sales@ebeestock.com
COAXIAL & FIBER OPTICS

DWG TITLE ET34925		DES. CABLE ASSEMBLY, UMCX PLUG TO REVERSE POLARITY MCX JACK BULKHEAD, RG178B/U			
REV. -	FSCM NO. 53919	CAD FILE 031408	SCALE N/A	SIZE A	127

- NOTES:
- UNLESS OTHERWISE SPECIFIED ALL DIMENSIONS ARE NOMINAL.
 - ALL SPECIFICATIONS ARE SUBJECT TO CHANGE WITHOUT NOTICE AT ANY TIME.
 - DIMENSIONS ARE IN INCHES.
 - LENGTH TOLERANCE IS $\pm 1.5\%$ OR $3/8"$, WHICHEVER IS GREATER.