

COMPONENTS	IMPEDANCE
SMA FEMALE 2 HOLE PANEL MOUNT	50 OHM
SMA FEMALE 2 HOLE PANEL MOUNT	50 OHM
RG405/U	50 OHM

Standard Lengths	
-12	12"
-24	24"
-36	36"
-48	48"
-60	60"
-XXX	Custom Length in inches

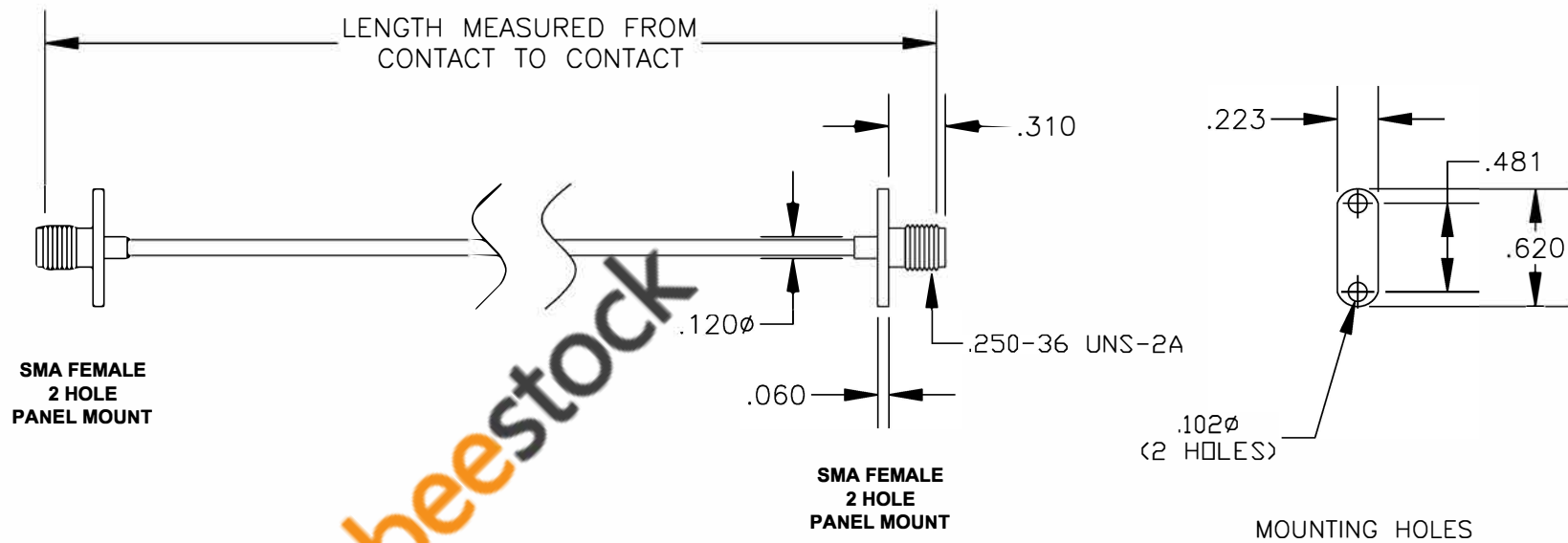

**8TH FLOOR, BUILDING 1, YONGFU SCIENCE AND TECHNOLOGY CENTER INDUSTRIAL PARK, NANZHA DISTRICT 5, HUMEN, 523900, DONGGUAN, GUANGDONG, CHINA**  
 WEBSITE: [www.ebeestock.com](http://www.ebeestock.com)  
 EMAIL: [sales@ebeestock.com](mailto:sales@ebeestock.com)  
**COAXIAL & FIBER OPTICS**  
 ESTABLISHED 2003

DWG TITLE	<b>ET35524</b>	DES.	CABLE ASSEMBLY, RG405/U, SMA FEMALE 2 HOLE PANEL MOUNT TO SMA FEMALE 2 HOLE PANEL MOUNT (LEAD FREE)
-----------	----------------	------	---

REV. A	<b>FSCM NO. 53919</b>	CAD FILE	012208	SCALE	N/A	SIZE	A 147
--------	-----------------------	----------	--------	-------	-----	------	-------

- NOTES:**
1. UNLESS OTHERWISE SPECIFIED ALL DIMENSIONS ARE NOMINAL.
  2. ALL SPECIFICATIONS ARE SUBJECT TO CHANGE WITHOUT NOTICE AT ANY TIME.
  3. DIMENSIONS ARE IN INCHES.
  4. LENGTH TOLERANCE IS  $\pm 1.5\%$  OR  $\pm 3/8"$ , WHICHEVER IS GREATER.