

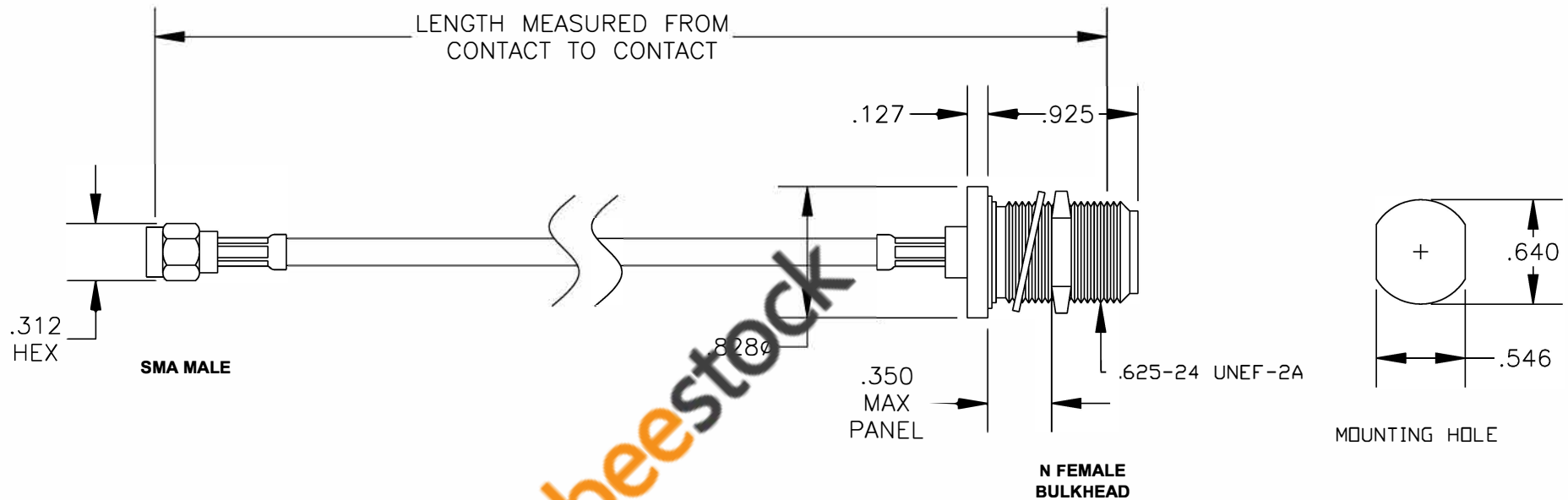

COMPONENTS	IMPEDANCE
SMA MALE	50 OHM
N FEMALE BULKHEAD	50 OHM
RG142B/U	50 OHM

Standard Lengths	
-12	12"
-24	24"
-36	36"
-48	48"
-60	60"
-XXX	Custom Length in inches



ebeestock

 <p>8TH FLOOR, BUILDING 1, YONGFU SCIENCE AND TECHNOLOGY CENTER INDUSTRIAL PARK, NANZHA DISTRICT 5, HUMEN, 523900, DONGGUAN, GUANGDONG, CHINA</p> <p>WEBSITE: www.ebeestock.com EMAIL: sales@ebeestock.com COAXIAL & FIBER OPTICS</p> <p>ESTABLISHED 2003</p>	
DWG TITLE	ET35646
DES.	CABLE ASSEMBLY, RG142B/U, SMA MALE TO N FEMALE BULKHEAD
REV. A	FSCM NO. 53919
CAD FILE	021308
SCALE	N/A
SIZE	A 147

NOTES:

1. UNLESS OTHERWISE SPECIFIED ALL DIMENSIONS ARE NOMINAL.
2. ALL SPECIFICATIONS ARE SUBJECT TO CHANGE WITHOUT NOTICE AT ANY TIME.
3. DIMENSIONS ARE IN INCHES.
4. LENGTH TOLERANCE IS $\pm 1.5\%$ OR $\pm 3/8"$, WHICHEVER IS GREATER.