

COMPONENTS	IMPEDANCE
SMA MALE RIGHT ANGLE	50 OHM
SMA FEMALE BULKHEAD	50 OHM

Standard Lengths	
-12	12"
-24	24"
-36	36"
-48	48"
-60	60"
-XXX	Custom Length in Inches

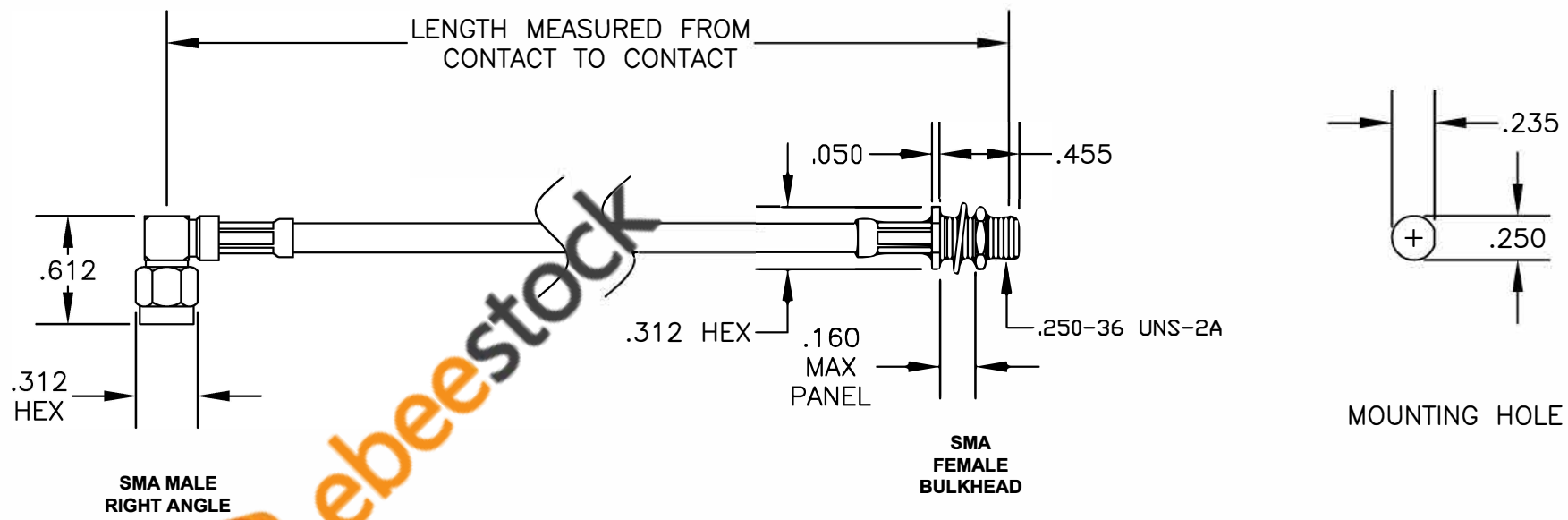

8TH FLOOR, BUILDING 1, YONGFU SCIENCE AND TECHNOLOGY  
CENTER INDUSTRIAL PARK, NANZHA DISTRICT 5,  
HUMEN, 523900, DONG GUAN, GUANGDONG, CHINA

WEBSITE: [www.ebeestock.com](http://www.ebeestock.com)  
EMAIL: [sales@ebeestock.com](mailto:sales@ebeestock.com)  
COAXIAL & FIBER OPTICS

DWG TITLE DES. CABLE ASSEMBLY, SMA MALE  
RIGHT ANGLE TO SMA FEMALE BULKHEAD

ET35820

REV. B	FSCM NO. 53919	CAD FILE 050409	SCALE N/A	SIZE A	147
--------	----------------	-----------------	-----------	--------	-----

**NOTES:**  
 1. UNLESS OTHERWISE SPECIFIED ALL DIMENSIONS ARE NOMINAL.  
 2. ALL SPECIFICATIONS ARE SUBJECT TO CHANGE WITHOUT NOTICE AT ANY TIME.  
 3. DIMENSIONS ARE IN INCHES.  
 4. LENGTH TOLERANCE IS ± 1.5% OR 3/8", WHICHEVER IS GREATER.