

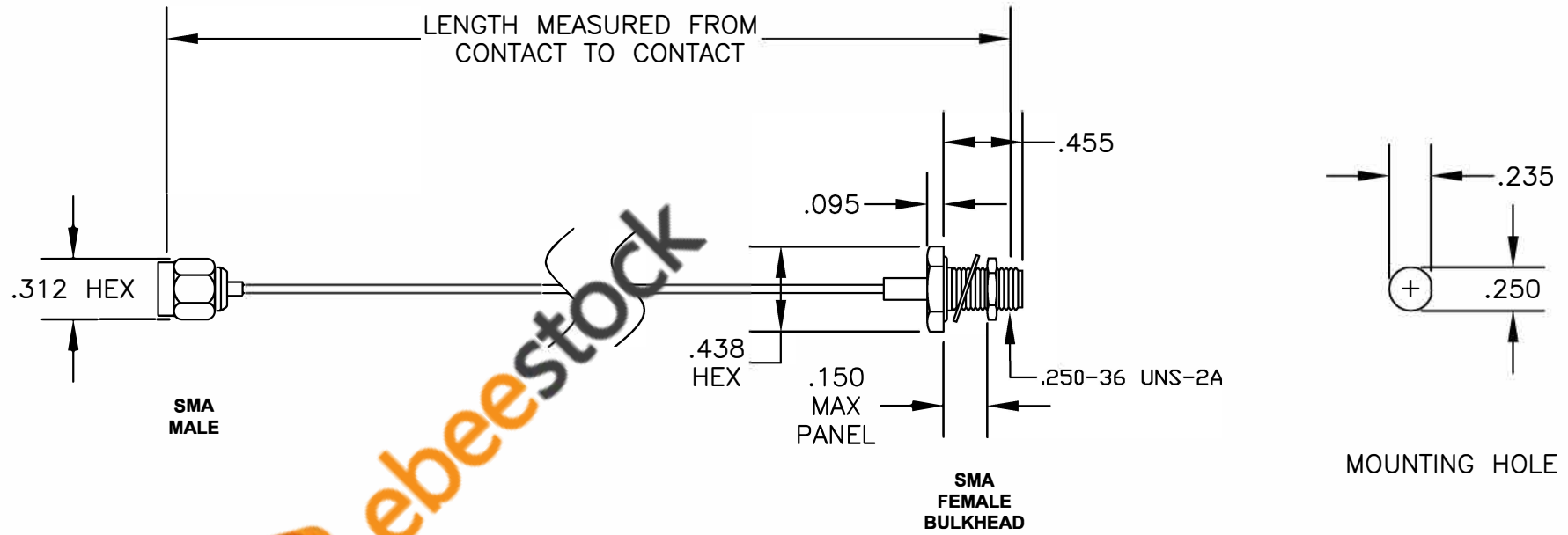

COMPONENTS	IMPEDANCE
SMA MALE	50 OHM
SMA FEMALE BULKHEAD	50 OHM

Standard Lengths	
-12	12"
-24	24"
-36	36"
-48	48"
-60	60"
-XXX	Custom Length in inches





8TH FLOOR, BUILDING 1, YONGFU SCIENCE AND TECHNOLOGY
CENTER INDUSTRIAL PARK, NANZHA DISTRICT 5,
HUMEN, 523900, DONGGUAN, GUANGDONG, CHINA

ebeestock
ESTABLISHED 2003

WEBSITE: www.ebeestock.com
EMAIL: sales@ebeestock.com
COAXIAL & FIBER OPTICS

DWG TITLE ET35879	DES. CABLE ASSEMBLY, SMA MALE , TO SMA FEMALE BULKHEAD
SIZE A FSCMNO.53919	CAD FILE 022707 SCALE N/A 127

NOTES:
 1. UNLESS OTHERWISE SPECIFIED ALL DIMENSIONS ARE NOMINAL.
 2. ALL SPECIFICATIONS ARE SUBJECT TO CHANGE WITHOUT NOTICE AT ANY TIME.
 3. DIMENSIONS ARE IN INCHES.
 4. LENGTH TOLERANCE IS ± 1.5% OR ±3/8", WHICHEVER IS GREATER.