

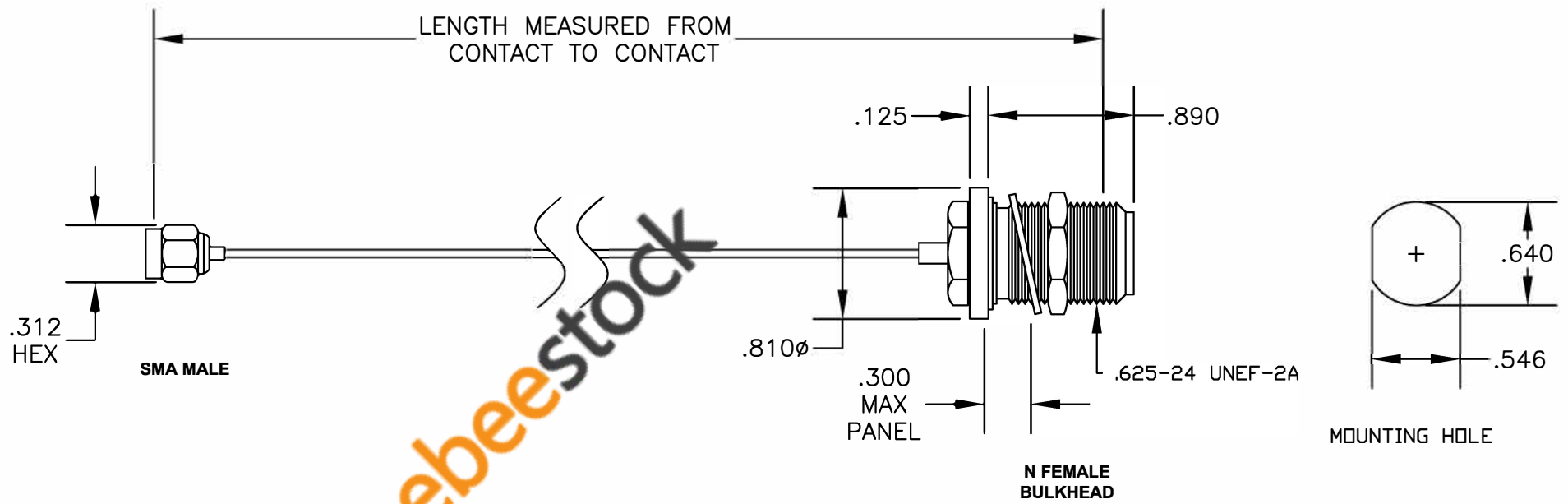

COMPONENTS	IMPEDANCE
SMA MALE	50 OHM
N FEMALE BULKHEAD	50 OHM

Standard Lengths	
-12	12"
-24	24"
-36	36"
-48	48"
-60	60"
-XXX	Custom Length in inches



**8TH FLOOR, BUILDING 1, YONGFU SCIENCE AND TECHNOLOGY CENTER INDUSTRIAL PARK, NANZHA DISTRICT 5, HUMEN, 523900, DONGGUAN, GUANGDONG, CHINA**  
 WEBSITE: [www.ebeestock.com](http://www.ebeestock.com)  
 EMAIL: [sales@ebeestock.com](mailto:sales@ebeestock.com)  
 ESTABLISHED 2003  
**COAXIAL & FIBER OPTICS**

DWG TITLE	DES. CABLE ASSEMBLY, SMA MALE , TO N FEMALE BULKHEAD			
<b>ET36191</b>	SIZE A	FSCM NO. 53919	CAD FILE 022807	SCALE N/A
<b>NOTES:</b> 1. UNLESS OTHERWISE SPECIFIED ALL DIMENSIONS ARE NOMINAL. 2. ALL SPECIFICATIONS ARE SUBJECT TO CHANGE WITHOUT NOTICE AT ANY TIME. 3. DIMENSIONS ARE IN INCHES. 4. LENGTH TOLERANCE IS $\pm 1.5\%$ OR $\pm 3/8"$ , WHICHEVER IS GREATER.				