

COMPONENTS	IMPEDANCE
SMA MALE	50 OHM
SMA FEMALE BULKHEAD	50 OHM

Standard Lengths	
-12	12"
-24	24"
-36	36"
-48	48"
-60	60"
-XXX	Custom Length in inches

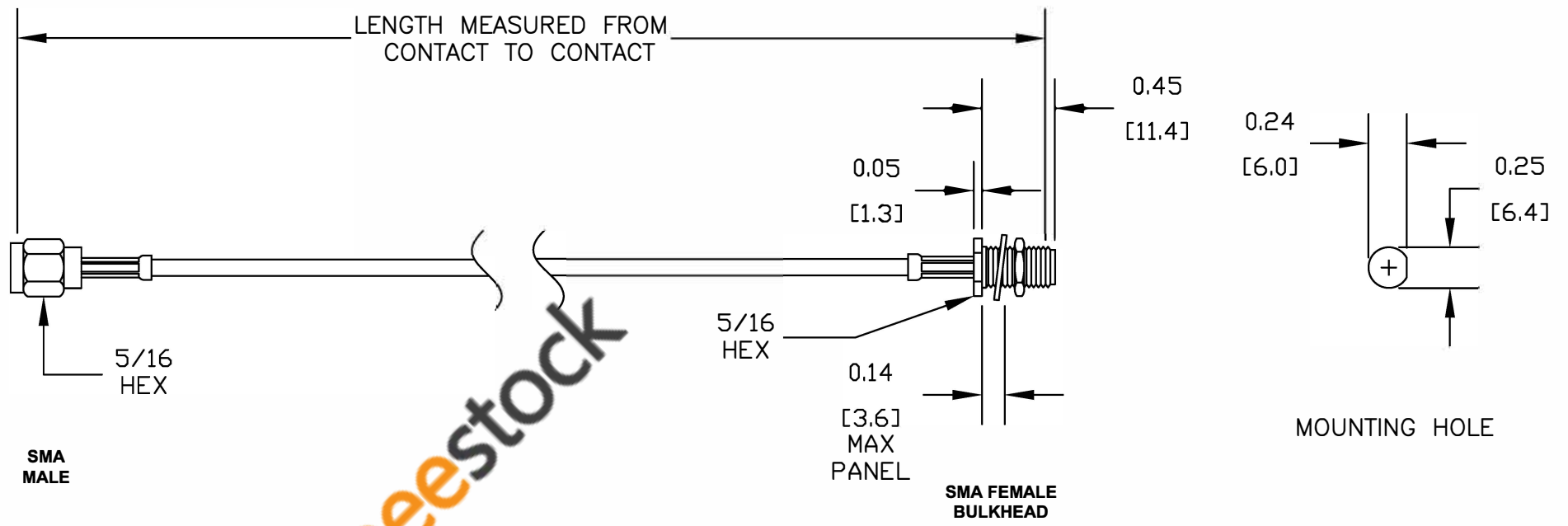

8TH FLOOR, BUILDING 1, YONGFU SCIENCE AND TECHNOLOGY CENTER INDUSTRIAL PARK, NANZHA DISTRICT 5, HUMEN, 523900, DONGGUAN, GUANGDONG, CHINA
 WEBSITE: www.ebeestock.com
 EMAIL: sales@ebeestock.com

ET36647	DES. CABLE ASSEMBLY, PE-C100, SMA MALE TO SMA FEMALE BULKHEAD
----------------	---

REV. -	FSCM NO. 53919	CAD FILE 082411	SCALE N/A	SIZE A	2231
--------	-----------------------	-----------------	-----------	--------	------

- NOTES:**
- UNLESS OTHERWISE SPECIFIED ALL DIMENSIONS ARE NOMINAL.
 - ALL SPECIFICATIONS ARE SUBJECT TO CHANGE WITHOUT NOTICE AT ANY TIME.
 - DIMENSIONS ARE IN INCHES [mm].
 - LENGTH TOLERANCE IS $\pm 1.5\%$ OR $3/8"$, WHICHEVER IS GREATER.